

SL60

Basic self-levelling pedestal

January 2025

DESCRIPTION:

Modules are used with self-levelling system in tile applications to create raised floors. Allow auto slope correction on surfaces maximum up to 5% gradient.



FEATURES:

Raw material	Polypropylene
Height range	Adjustable min.42 mm - max. 260 mm (Optionally, extra 'extension' can be used to increase the height more than 260 mm)
Base diameter	187 mm
Base wall thickness	3 mm
Head diameter	126 mm
Laying surface of base	302 cm ²
Tab thickness	2 mm/3 mm/4 mm (removable)
Tab height	10 mm
Slope correction	% 5
Environmental impact assessment	Eco friendly

APPLICATION AREAS:

Can be used for all indoor and outdoor areas. Also, on levelled surfaces, epoxy or membrane insulated areas.

APPLICATION:

Use of any fixing material is not necessary. Optionally, the modules can be fixed to the application surface using adhesive or screw.

RAW MATERIAL:

Carrier	Polypropylene
Product code	240 KTPH
Product colour	Black
Filler	Calcium carbonate (CaCO ₃)



SL60 TECHNICAL DRAWING:

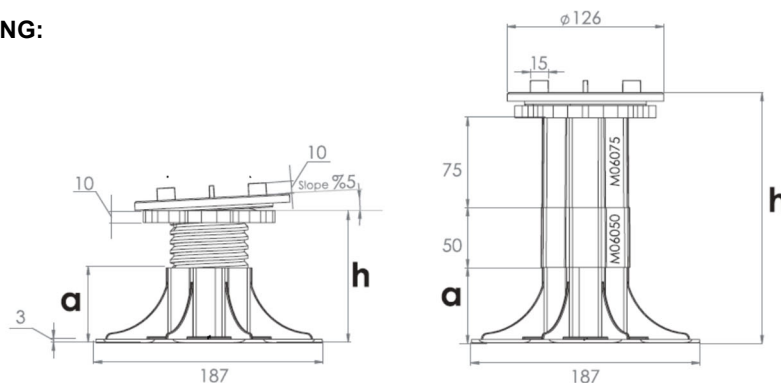
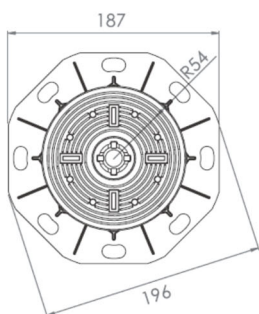

SL60

Basic self-levelling pedestal

January 2025

SL60 DIMENSION AND WEIGHT:

Model	SL60-01	SL60-02	SL60-03	SL60-04	SL60-05	SL60-06	SL60-07	SL60-08	SL60-09	SL60-10
a	18 mm	27 mm	40 mm	62 mm	40 mm	62 mm	62 mm	62 mm	62 mm	62 mm
h (min. - max)	42-48 mm	48-60 mm	60-85 mm	83-120 mm	112-140 mm	136-165 mm	157-194 mm	185-215 mm	210-235 mm	230-260 mm
Extension	-	-	-	-	M06050	M06050	M06075	M06050	M06050 M06075	M06075
Weight	0,243 kg	0,254 kg	0,271 kg	0,305 kg	-	-	-	-	-	-
Comp.										

SL60 PRESSURE RESISTANCE:

Pressure measuring point

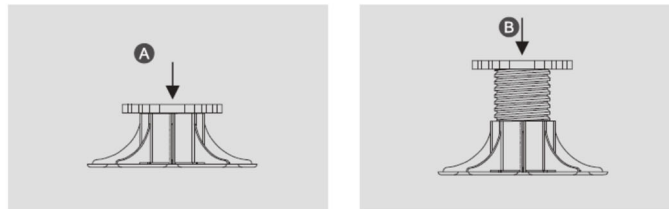

A Minimum highness

COMPRESSION TEST (HOT 23°)

B Maximum highness

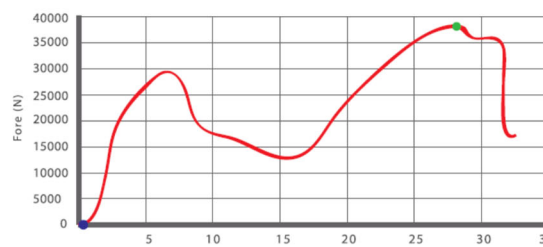
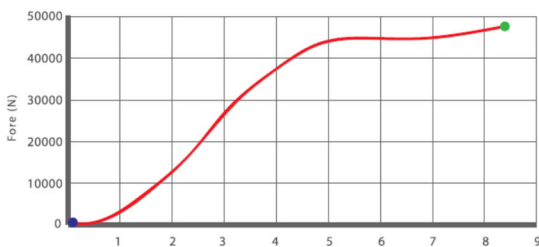

A Minimum highness

COMPRESSION TEST (COLD -40°)

B Maximum highness

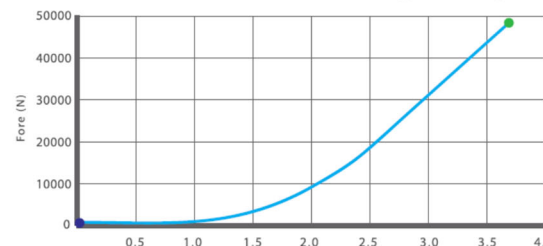
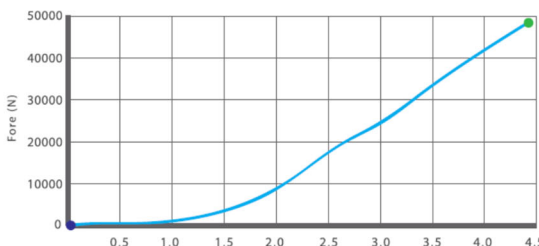

TESTED AND APPROVED BY HEADSHIP OF TURKISH STANDARDS INSTITUTION (TSE) AND CALIBRATION CENTER CONSTRUCTION MATERIALS LABORATORY (ANKARA CITY)

SL60

Basic self-levelling pedestal

January 2025

SL60 PACKAGING INFORMATION:

Product code	SL60-01	SL60-02	SL60-03	SL60-04	M06050	M06075
Pcs per box	70*	60*	45*	35*	60***	40***
Gross weight per box	18,50 kg	16,65 kg	13,60 kg	12,10 kg	5,40 kg	4,00 kg
Boxes per pallet	12	12	12	12	48	48
Box dimensions	60cm x 40cm [*] x h=40cm		40cm x 30cm ^{**} x h=41cm		40cm x 30cm ^{***} x h=20cm	
Gross weight per pallet	247 kg	225 kg	189 kg	170 kg	285 kg	217 kg
Pallet dimensions	cm 80 x 120 x h140					

- Products are packed in cardboard boxes. Shrink-wrapped euro-pallets are used for final packaging. In spite of being shrink wrapped and rain proof packaging, it is recommended to keep the pallets in a closed area.
- The technical data products above indicate the current production. It may be updated or modified at any time without prior notice.
- We do not take any responsibility for any problem caused by misuse of the products.

WARNINGS AND BANS:

Is the building product/building product line subject to warning or ban under section 26 of the Building Act 2004?	No
--	----

MANUFACTURERS CONTACT DETAILS:

Manufacture location	Turkey
Legal and trading name of manufacturer	Ozturk Plastic Kalip San. Tic. Ltd. Sti.
Manufacturer address for service	Ikitelli Org.San.Bol. Mah. Enkoop Cad. No:4/C Blok Basaksehir / Istanbul
Manufacturer website	Www.fixplus.com.tr
Manufacturer email	orders@tremco.com.au
Manufacturer phone number	+90 212 485 24 53