



EQUUS TRAXX FLOORING SYSTEM

Standard Details



CELEBRATING
40 YEARS
1982-2022

MARCH 2024

CONTENTS

ETF-D1a	Floor Coating Build Up (3D)	1
ETF-D1	Floor Coating Build Up	2
ETF-D2	Floor Drain	3
ETF-D3	Concrete Plinth	4
ETF-D4	Nib Detail	5
ETF-D5	Channel Drain	6
ETF-D6	Cool Store Panel Wall	7
ETF-D7	Standard Fixing	8
ETF-D8	Penetration Detail	9
ETF-D14	Typical Details	10

- ① EQUUS Traxx Primer appropriate for substrate
- ② EQUUS Traxx
- ③ EQUUS Traxx

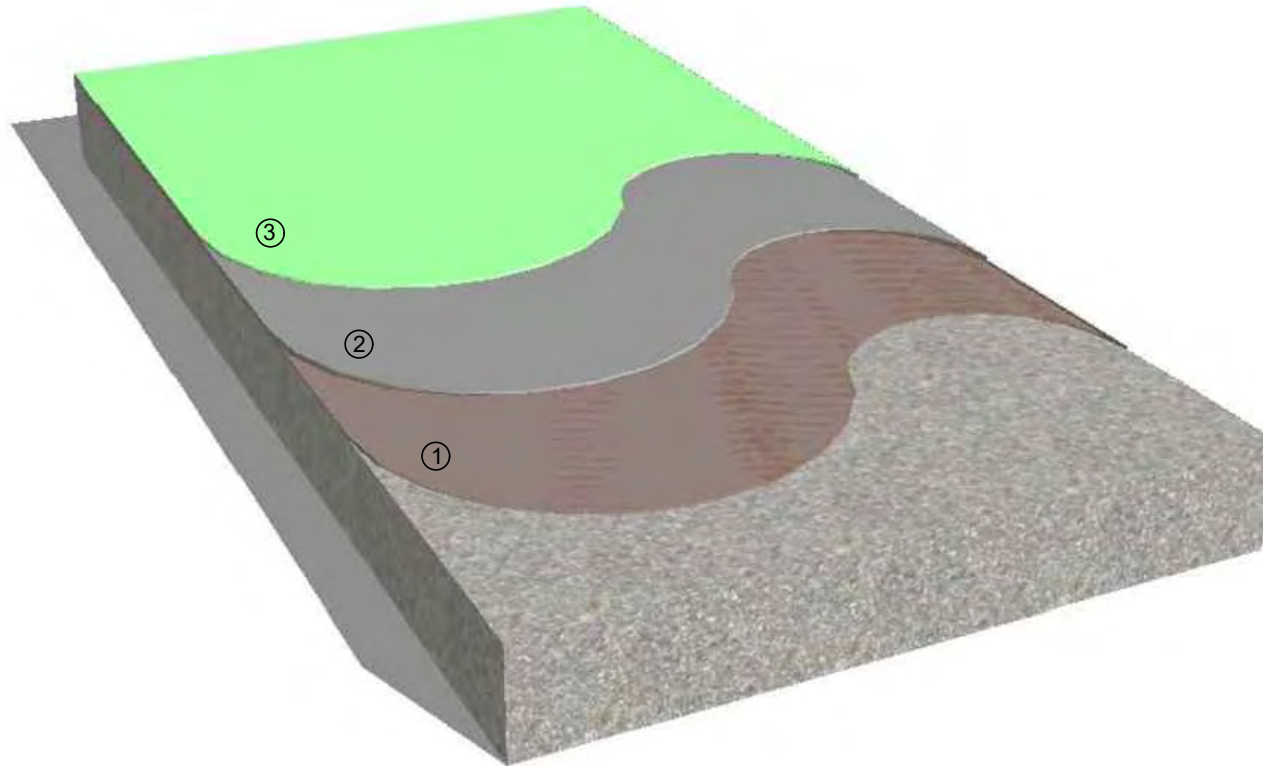

PRODUCT :	EQUUS Traxx Flooring on Concrete Substrate Standard Detail		
TITLE :	Floor coating build up detail		
NUMBER :	ETF-D1a	SCALE :	NTS
DRAWN BY :	NKT	DATE :	15-Mar-2024
		REVISED :	

Equus standard details are especially drawn for use by Local Authorities, Building Contractors, Equus Applicators, Architects and design professionals. All details are drawn to assist in the development of project-specific details. Details may be modified where necessary to accommodate job-specific requirements but must be approved by Equus Industries Ltd. All components must be supplied by Equus Industries Ltd. Equus reserves the right to alter or upgrade details at any time without prior notice.

- ① EQUUS Traxx Primer appropriate for substrate
- ② EQUUS Traxx
- ③ EQUUS Traxx

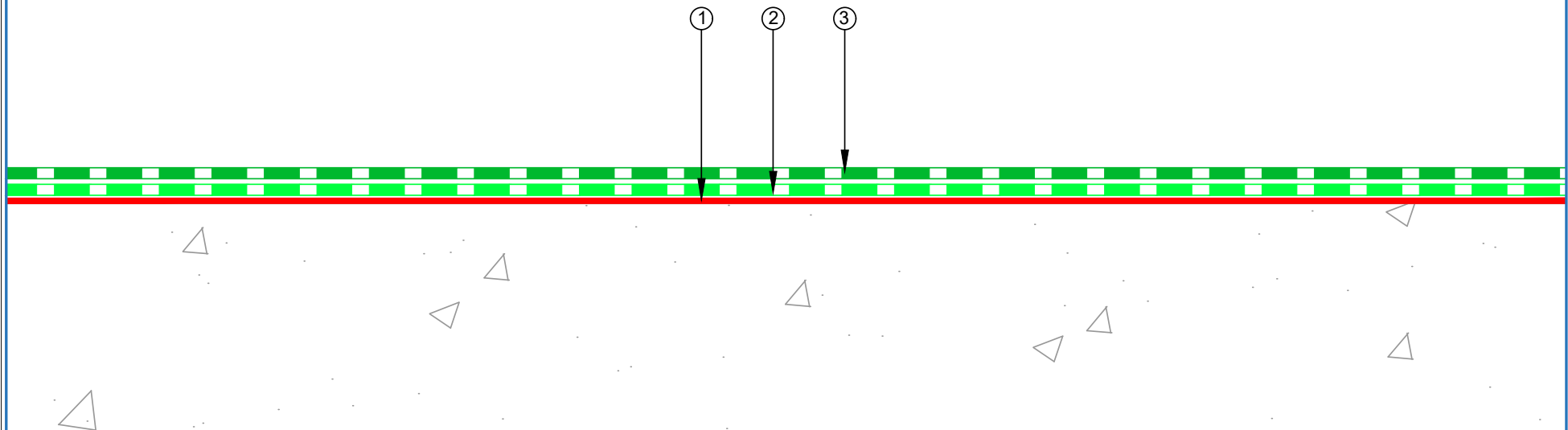

 <p>E-mail : info@equus.nz Web : www.equus.nz</p>	PRODUCT :	EQUUS Traxx Flooring on Concrete Substrate Standard Detail		
	TITLE :	Floor coating build up detail		
	NUMBER :	ETF-D1	SCALE :	NTS
	DRAWN BY :	NKT	DATE :	15-Mar-2024
	REVISED :			
<p>Equus standard details are especially drawn for use by Local Authorities, Building Contractors, Equus Applicators, Architects and design professionals. All details are drawn to assist in the development of project-specific details. Details may be modified where necessary to accommodate job-specific requirements but must be approved by Equus Industries Ltd. All components must be supplied by Equus Industries Ltd. Equus reserves the right to alter or upgrade details at any time without prior notice.</p>				

- ① EQUUS Traxx Primer appropriate for substrate
- ② EQUUS Traxx
- ③ EQUUS Traxx
- ④ EQUUS Dymonic 100 sealant

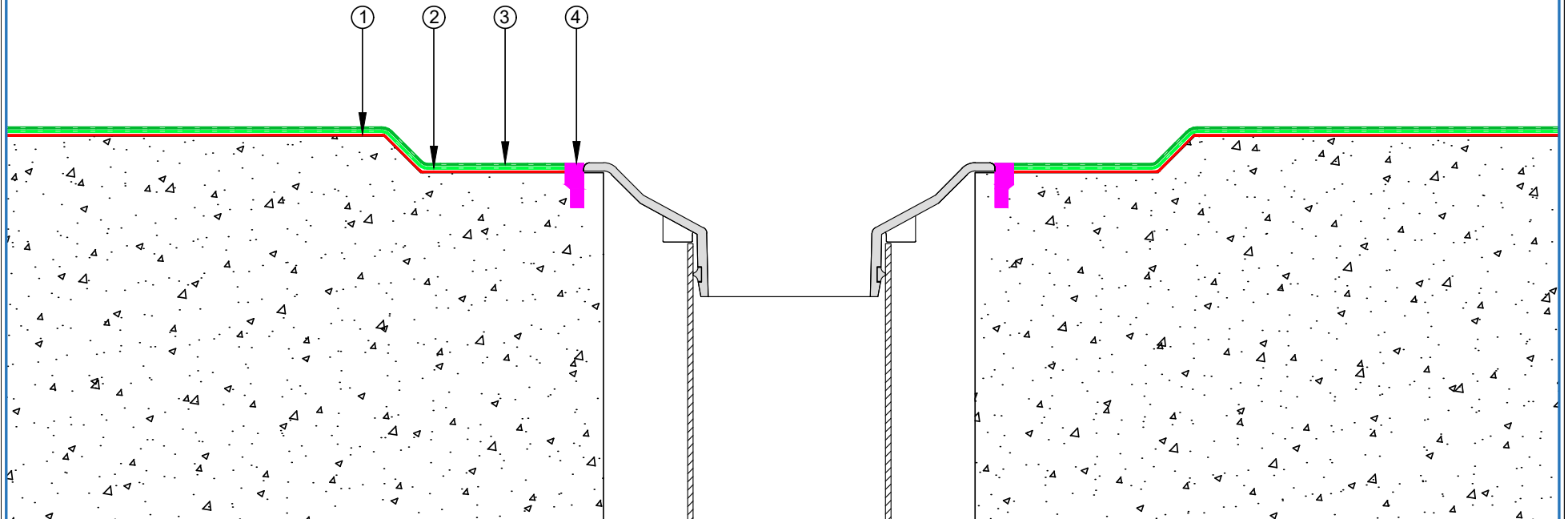

 E-mail : info@equus.nz Web : www.equus.nz	PRODUCT :	EQUUS Traxx Flooring on Concrete Substrate Standard Detail		
	TITLE :	Floor drain detail		
	NUMBER :	ETF-D2	SCALE :	NTS
	DRAWN BY :	NKT	DATE :	15-Mar-2024
			REVISED :	
Equus standard details are especially drawn for use by Local Authorities, Building Contractors, Equus Applicators, Architects and design professionals. All details are drawn to assist in the development of project-specific details. Details may be modified where necessary to accommodate job-specific requirements but must be approved by Equus Industries Ltd. All components must be supplied by Equus Industries Ltd. Equus reserves the right to alter or upgrade details at any time without prior notice.				

- ① EQUUS Traxx Primer appropriate for substrate
- ② EQUUS Traxx
- ③ EQUUS Traxx
- ④ Mortar fillet

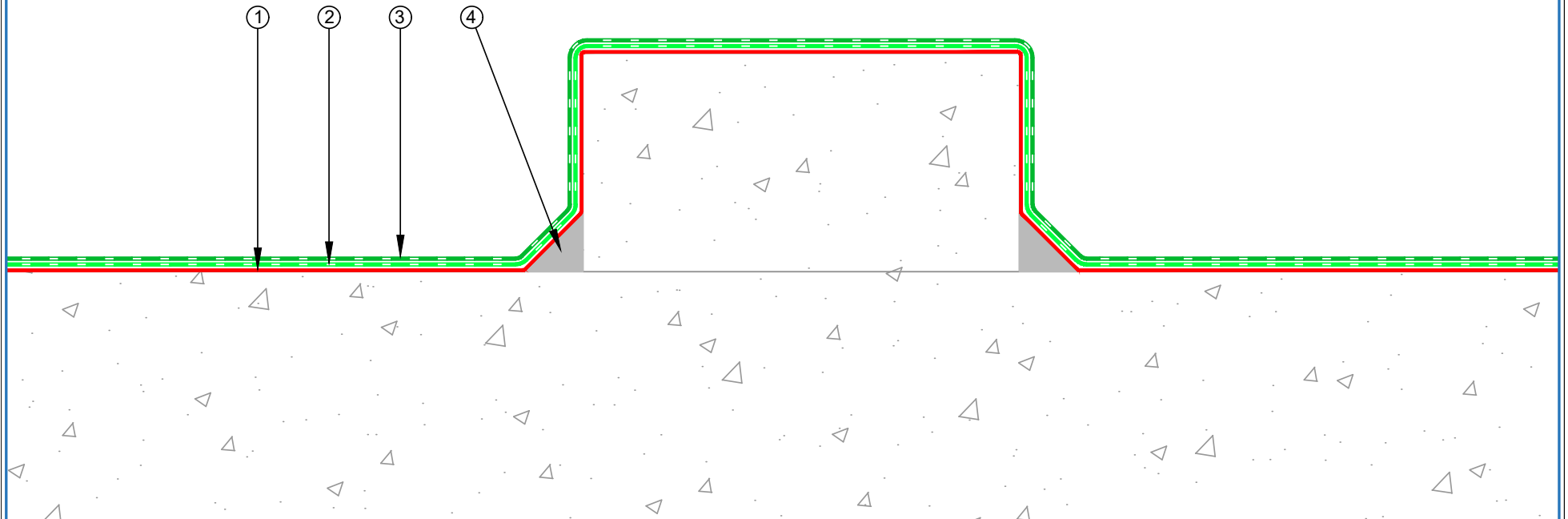

PRODUCT :	EQUUS Traxx Flooring on Concrete Substrate Standard Detail		
TITLE :	Concrete plinth detail		
NUMBER :	ETF-D3	SCALE :	NTS
DRAWN BY :	NKT	DATE :	15-Mar-2024
REVISD :			
Equus standard details are especially drawn for use by Local Authorities, Building Contractors, Equus Applicators, Architects and design professionals. All details are drawn to assist in the development of project-specific details. Details may be modified where necessary to accommodate job-specific requirements but must be approved by Equus Industries Ltd. All components must be supplied by Equus Industries Ltd. Equus reserves the right to alter or upgrade details at any time without prior notice.			

- ① EQUUS Traxx Primer appropriate for substrate
- ② EQUUS Traxx
- ③ EQUUS Traxx
- ④ Mortar fillet

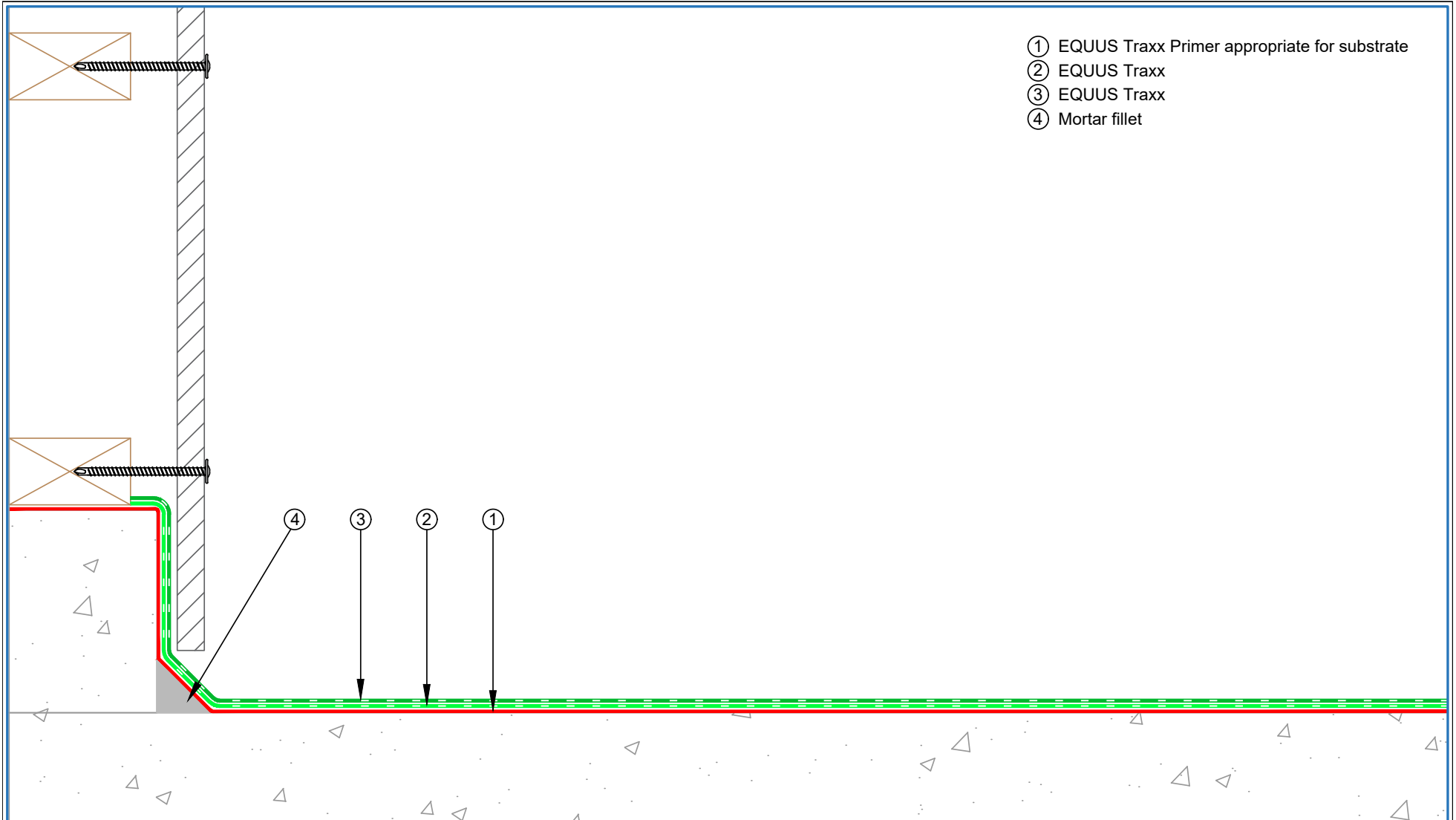

PRODUCT :	EQUUS Traxx Flooring on Concrete Substrate Standard Detail		
TITLE :	Nib detail		
NUMBER :	ETF-D4	SCALE :	NTS
DRAWN BY :	NKT	DATE :	15-Mar-2024
		REVISED :	
Equus standard details are especially drawn for use by Local Authorities, Building Contractors, Equus Applicators, Architects and design professionals. All details are drawn to assist in the development of project-specific details. Details may be modified where necessary to accommodate job-specific requirements but must be approved by Equus Industries Ltd. All components must be supplied by Equus Industries Ltd. Equus reserves the right to alter or upgrade details at any time without prior notice.			

- ① EQUUS Traxx Primer appropriate for substrate
- ② EQUUS Traxx
- ③ EQUUS Traxx
- ④ Mortar fillet

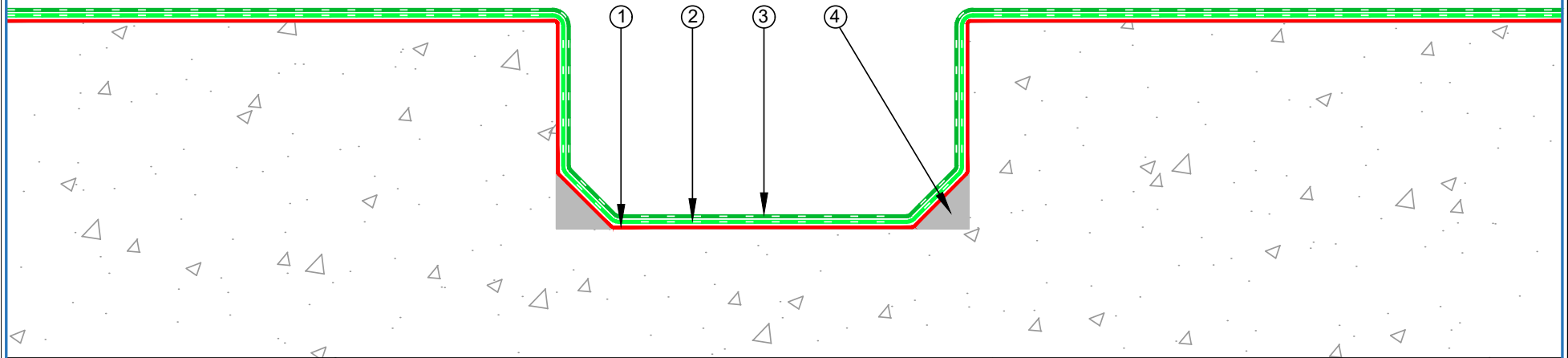

 E-mail : info@equus.nz Web : www.equus.nz	PRODUCT :	EQUUS Traxx Flooring on Concrete Substrate Standard Detail		
	TITLE :	Channel drain detail		
	NUMBER :	ETF-D5	SCALE :	NTS
	DRAWN BY :	NKT	DATE :	15-Mar-2024
			REVISED :	
<p>Equus standard details are especially drawn for use by Local Authorities, Building Contractors, Equus Applicators, Architects and design professionals. All details are drawn to assist in the development of project-specific details. Details may be modified where necessary to accommodate job-specific requirements but must be approved by Equus Industries Ltd. All components must be supplied by Equus Industries Ltd. Equus reserves the right to alter or upgrade details at any time without prior notice.</p>				

- ① EQUUS Traxx Primer appropriate for substrate
- ② EQUUS Traxx
- ③ EQUUS Traxx
- ④ Mortar fillet
- ⑤ EQUUS Dymonic 100 sealant

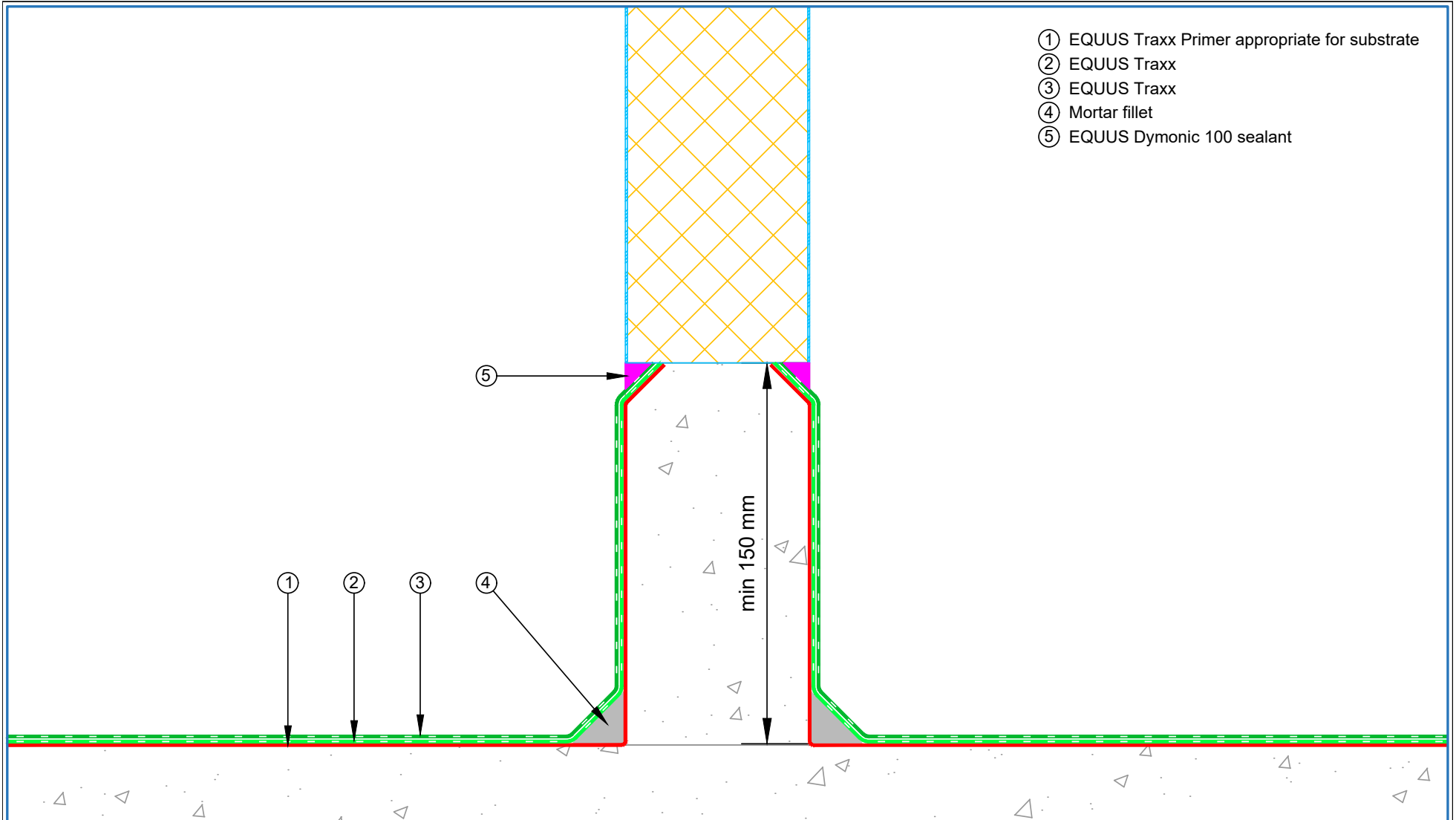

 E-mail : info@equus.nz Web : www.equus.nz	PRODUCT :	EQUUS Traxx Flooring on Concrete Substrate Standard Detail		
	TITLE :	Cool store panel wall detail		
	NUMBER :	ETF-D6	SCALE :	NTS
	DRAWN BY :	NKT	DATE :	15-Mar-2024
			REVISED :	
Equus standard details are especially drawn for use by Local Authorities, Building Contractors, Equus Applicators, Architects and design professionals. All details are drawn to assist in the development of project-specific details. Details may be modified where necessary to accommodate job-specific requirements but must be approved by Equus Industries Ltd. All components must be supplied by Equus Industries Ltd. Equus reserves the right to alter or upgrade details at any time without prior notice.				

- ① EQUUS Traxx Primer appropriate for substrate
- ② EQUUS Traxx
- ③ EQUUS Traxx
- ④ EQUUS Dymonic 100 sealant
- ⑤ Chemset Anchors
- ⑥ Neoprene washers

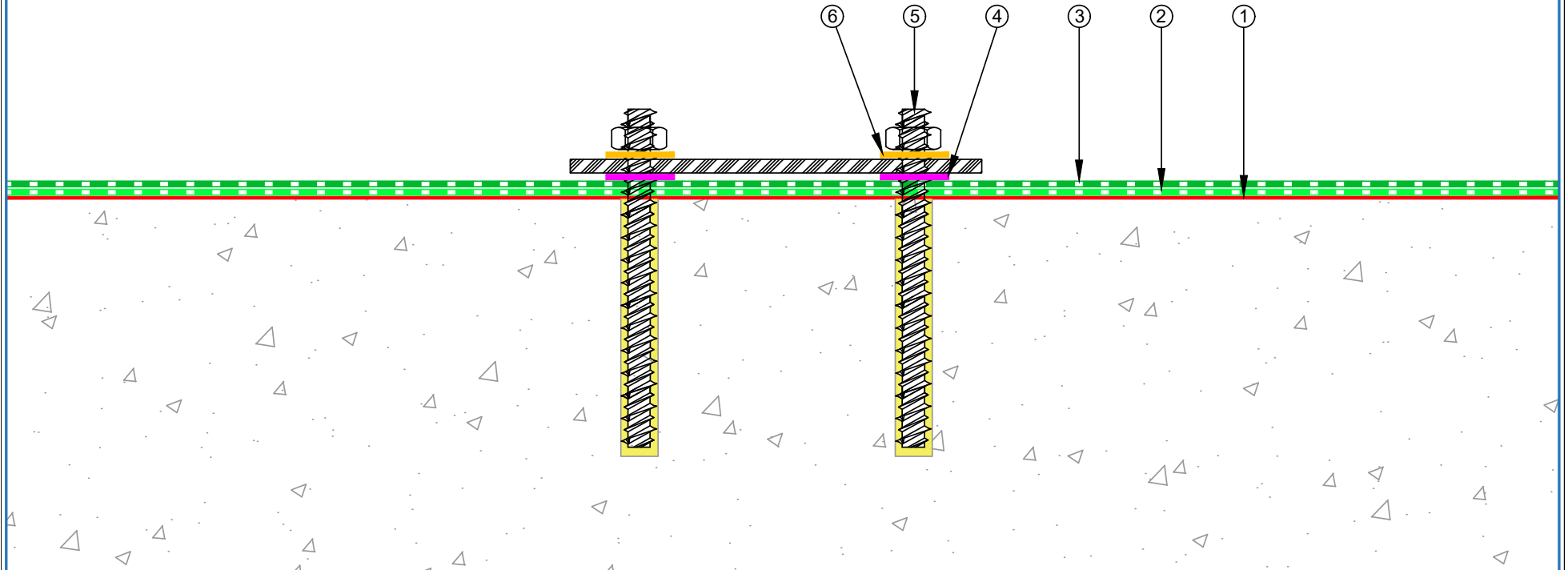

 E-mail : info@equus.nz Web : www.equus.nz	PRODUCT :	EQUUS Traxx Flooring on Concrete Substrate Standard Detail		
	TITLE :	Standard fixing detail		
	NUMBER :	ETF-D7	SCALE :	NTS
	DRAWN BY :	NKT	DATE :	15-Mar-2024
			REVISED :	
Equus standard details are especially drawn for use by Local Authorities, Building Contractors, Equus Applicators, Architects and design professionals. All details are drawn to assist in the development of project-specific details. Details may be modified where necessary to accommodate job-specific requirements but must be approved by Equus Industries Ltd. All components must be supplied by Equus Industries Ltd. Equus reserves the right to alter or upgrade details at any time without prior notice.				

- ① EQUUS Traxx Primer appropriate for substrate
- ② EQUUS Traxx
- ③ EQUUS Traxx
- ④ EQUUS Dymonic 100 sealant
- ⑤ Penetration

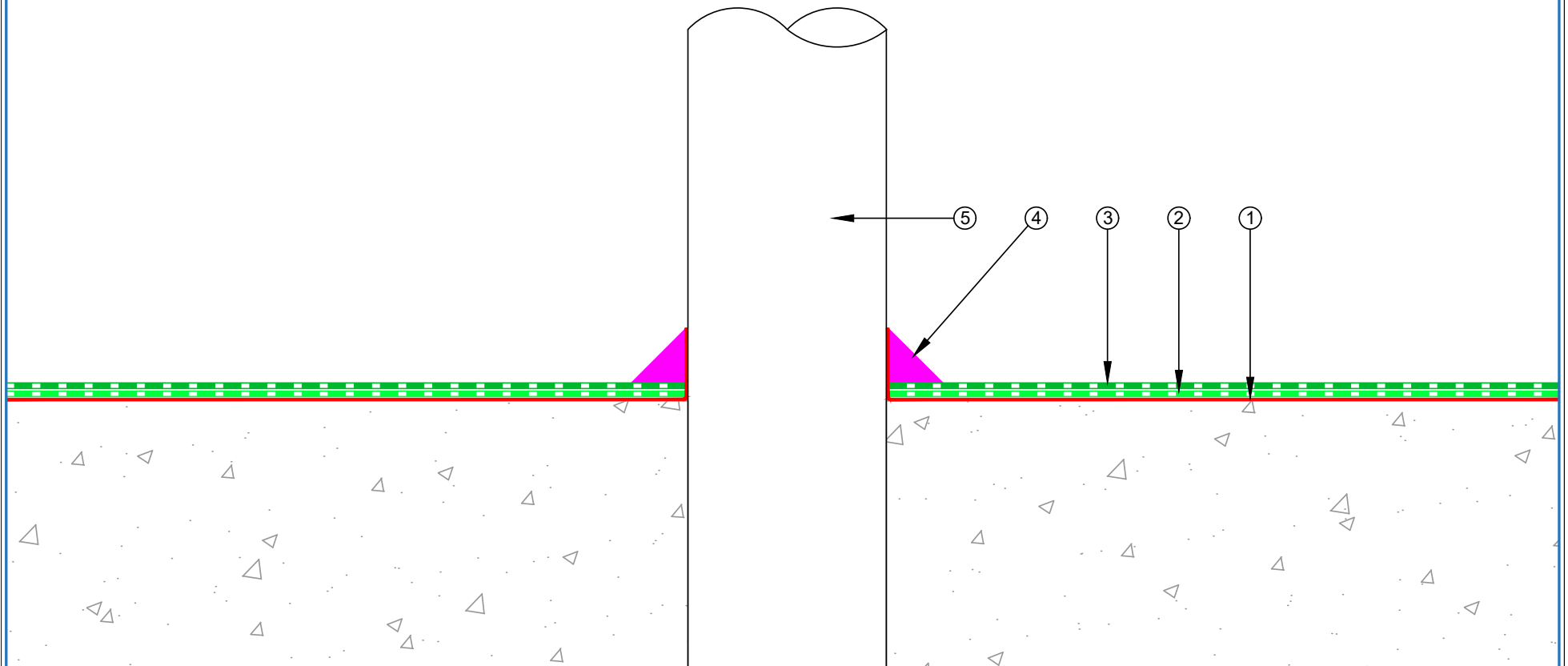

 E-mail : info@equus.nz Web : www.equus.nz	PRODUCT :	EQUUS Traxx Flooring on Concrete Substrate Standard Detail		
	TITLE :	Penetration detail		
	NUMBER :	ETF-D8	SCALE :	NTS
	DRAWN BY :	NKT	DATE :	15-Mar-2024
			REVISED :	
Equus standard details are especially drawn for use by Local Authorities, Building Contractors, Equus Applicators, Architects and design professionals. All details are drawn to assist in the development of project-specific details. Details may be modified where necessary to accommodate job-specific requirements but must be approved by Equus Industries Ltd. All components must be supplied by Equus Industries Ltd. Equus reserves the right to alter or upgrade details at any time without prior notice.				

CRACK IN THE SUBSTRATE

- ① Fabric
- ② EQUUS Dymonic 100 sealant
- ③ EQUUS Traxx Flooring

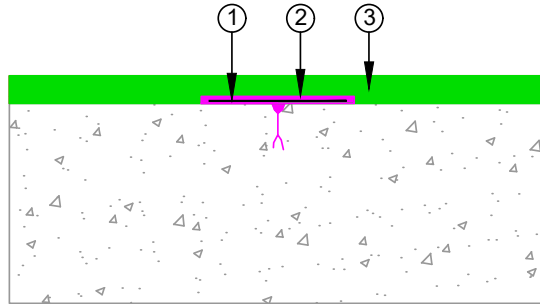

CONNECTIONS TO DRAINAGE SYSTEM & SUMPS

- ① Cut connection. Fill with EQUUS Dymonic 100 sealant
- ② EQUUS Traxx Flooring

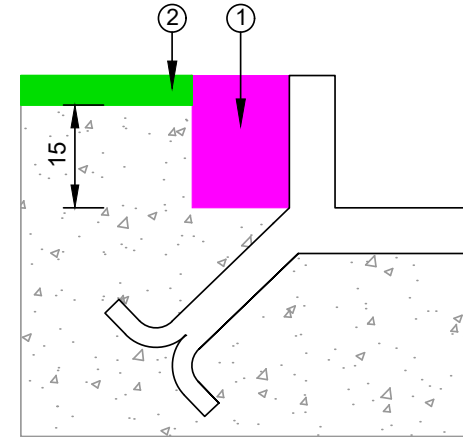

CONNECTION TO VERTICAL SURFACE
FREE CONNECTION AT THE DURACON FLOORING END

- ① EQUUS Traxx Flooring
- ② Connecting area

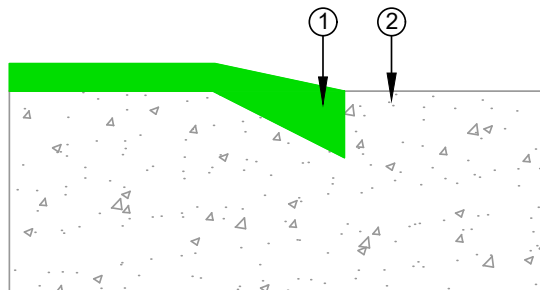

Expansion Joints

- ① EQUUS Traxx Flooring
- ② EQUUS Dymonic 100 sealant

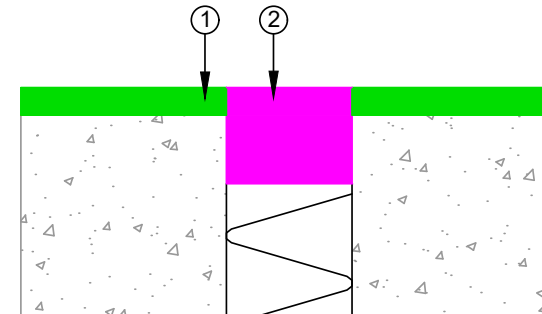

PRODUCT :	EQUUS Traxx Flooring on Concrete Substrate Standard Detail		
TITLE :	Typical Detail		
NUMBER :	ETF-D14	SCALE :	NTS
DRAWN BY :	NKT	DATE :	15-Mar-2024
Revised :			
Equus standard details are especially drawn for use by Local Authorities, Building Contractors, Equus Applicators, Architects and design professionals. All details are drawn to assist in the development of project-specific details. Details may be modified where necessary to accommodate job-specific requirements but must be approved by Equus Industries Ltd. All components must be supplied by Equus Industries Ltd. Equus reserves the right to alter or upgrade details at any time without prior notice.			