



EQUUS SOPREMA SOPRATHERM WARM ROOF SYSTEM

Standard Details on Metal Substrate



CELEBRATING
40 YEARS
1982-2022



MAY 2023

CONTENTS

SSWRM-D0a	Roof Build Up with PIR	1	SSWRM-D5b	Standard Pipe or SHS Penetration (Mineral Wool)	17
SSWRM-D0b	Roof Build Up with PIR and Roof Board	2	SSWRM-D5c	Standard Pipe or SHS Penetration with Cover Board (PIR)	18
SSWRM-D0c	Roof Build Up with Mineral Wool	3	SSWRM-D5d	Standard Pipe or SHS with Cover Board (Mineral Wool)	19
SSWRM-D0d	Roof Build Up with Mineral Wool and Roof Board	4	SSWRM-D6a	Electrical Conduit (PIR)	20
SSWRM-D1a	Concrete Parapet Detail with Roof Cap Flashing	5	SSWRM-D6b	Electrical Conduit (Mineral Wool)	21
SSWRM-D1b	Concrete Parapet with Roof Edge Profile (PIR)	6	SSWRM-D6c	Electrical Conduit with Roof Coverboard (Mineral Wool)	22
SSWRM-D1c	Concrete Parapet with Roof Cap Flashing (Mineral Wool)	7	SSWRM-D7a	Roof Equipment Support Batten (PIR)	23
SSWRM-D1d	Concrete Parapet with Roof Edge Profile (Mineral Wool)	8	SSWRM-D7b	Roof Equipment Support Batten (Mineral Wool)	24
SSWRM-D2a	Plywood Parapet with Roof Cap Flashing (PIR)	9	SSWRM-D7c	Roof Equipment Support Batten – Optional (PIR)	25
SSWRM-D2b	Plywood Parapet with Roof Edge Profile (PIR)	10	SSWRM-D7d	Roof Equipment Support Batten – Optional (Mineral Wool)	26
SSWRM-D2c	Plywood Parapet with Roof Cap Flashing (Mineral Wool)	11	SSWRM-D8a	Skylight (PIR)	27
SSWRM-D2d	Plywood Parapet with Roof Edge Profile (PIR)	12	SSWRM-D8b	Skylight (Mineral Wool)	28
SSWRM-D3a	Allproof Dome Clamp Ring Drain	13	SSWRM-D9a	Fall Restraint (PIR)	29
SSWRM-D3b	Aquaknight HiFlow Roof Drain	14	SSWRM-D9b	Fall Restraint (Mineral Wool)	30
SSWRM-D3c	Allproof Dome Clamp Ring Drain 168.80DCR	15	SSWRM-D10a	Connection to External Gutter (PIR)	31
SSWRM-D5a	Standard Pipe or SHS Penetration (PIR)	16	SSWRM-D10b	Connection to External Gutter (Mineral Wool)	32

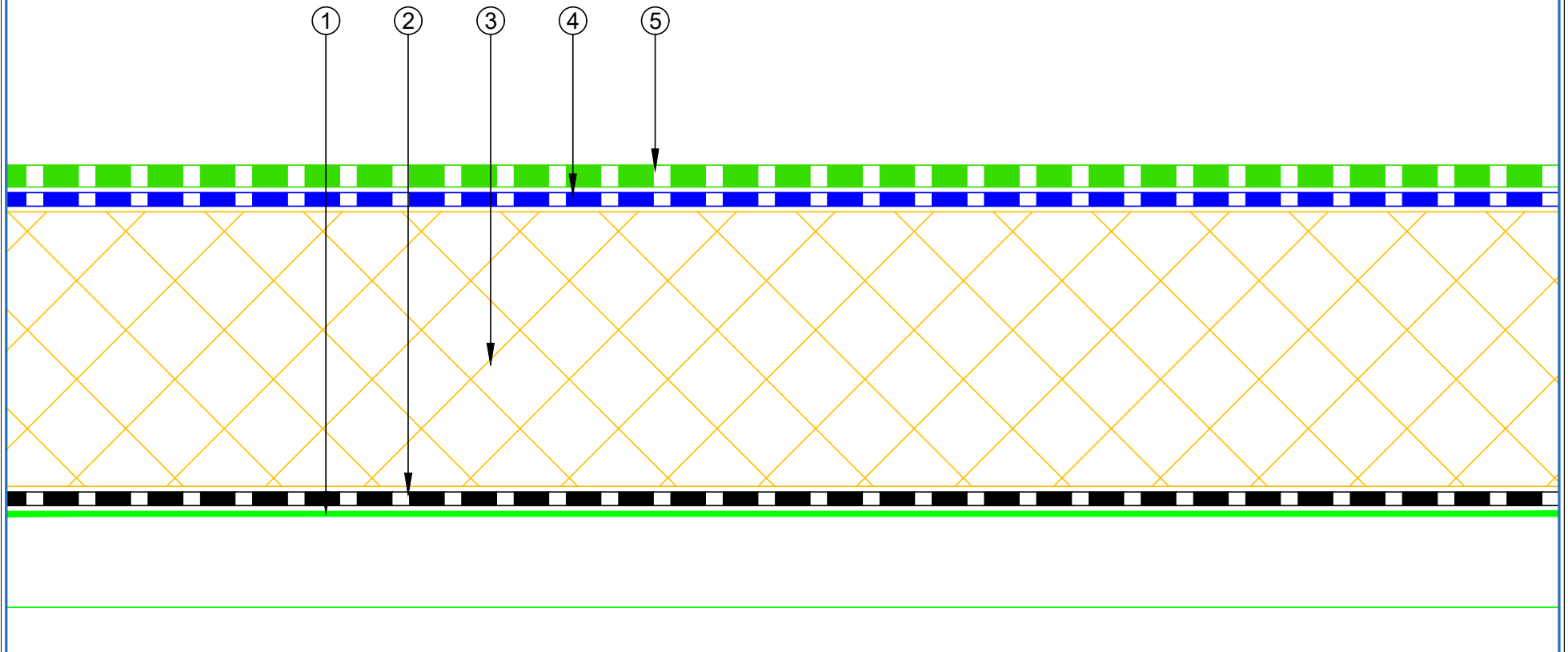

- ① Metal Roof Deck
- ② EQUUS Colphene 3000 Vapour Barrier
- ③ EQUUS PIR thermal insulation
- ④ EQUUS SOPRASUN PLUS 3 base sheet
- ⑤ EQUUS SOPRASUN PLUS MINERAL cap sheet

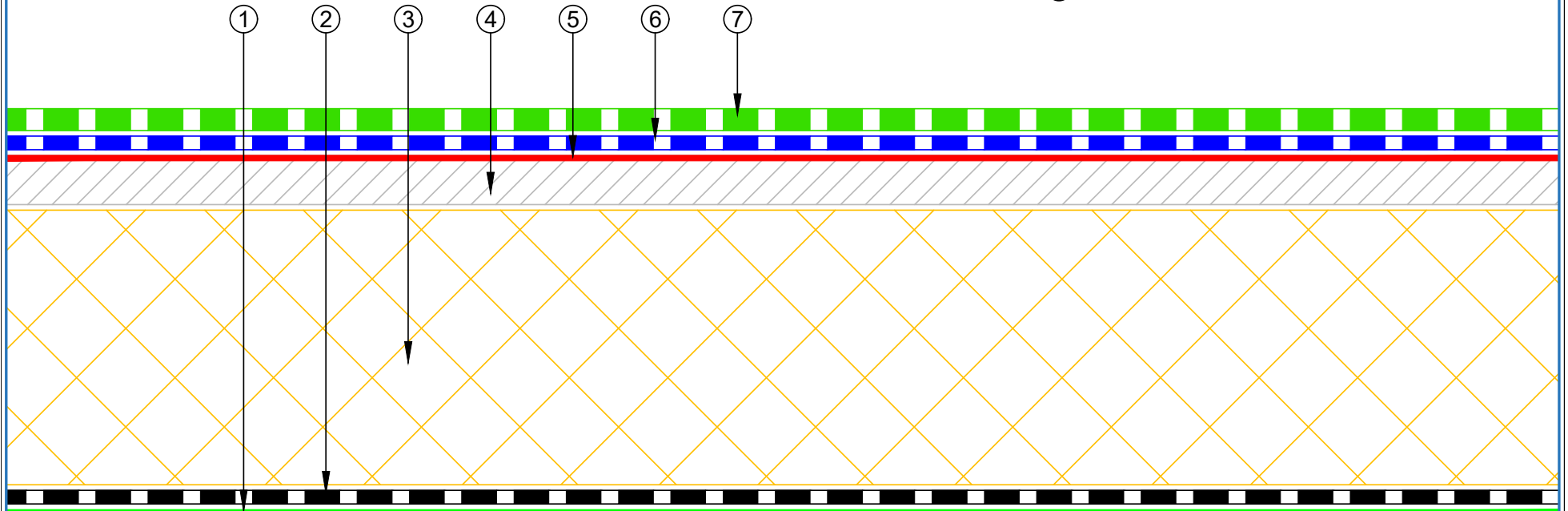

 E-mail : admin@equus.co.nz Web : www.equus.co.nz	PROJECT :		Warm Roof on Metal Standard Detail - SOPRASUN		 AUTHORISED DISTRIBUTOR SOPREMA	
	TITLE :		Roof build up with PIR			
	NUMBER :		SSWRM-D0a	SCALE :		1 : 1
	DRAWN BY :		NKT	DATE :		29-Aug-2022
				REVISED :		
<p><small>Equus Waterproof Membrane Details are specially drawn for use by Local Authorities, Building Contractors, Equus Applicators, Architects and design professionals. All details are drawn to assist in the development of project specific details. Details may be modified where necessary to accommodate job specific requirements but must be approved by Equus Industries Ltd. All components must be supplied by Equus Industries Ltd. Equus reserves the right to alter or upgrade details at any time without prior notice.</small></p>						

- ① Metal Roof Deck
- ② EQUUS Colphene 3000 Vapour Barrier
- ③ EQUUS PIR thermal insulation
- ④ EQUUS Permabase Dek roof cover board
- ⑤ EQUUS Sopradere Quick primer
- ⑥ EQUUS SOPRASUN PLUS 3 base sheet
- ⑦ EQUUS SOPRASUN PLUS MINERAL cap sheet



 E-mail : admin@equus.co.nz Web : www.equus.co.nz	PROJECT :		Warm Roof on Metal Standard Detail - SOPRASUN		 AUTHORISED DISTRIBUTOR SOPREMA	
	TITLE :		Roof build up with PIR and roof board			
	NUMBER :		SSWRM-D0b	SCALE :		1 : 1
	DRAWN BY :		NKT	DATE :		29-Aug-2022
				REVISED :		
<p><small>Equus Waterproof Membrane Details are specially drawn for use by Local Authorities, Building Contractors, Equus Applicators, Architects and design professionals. All details are drawn to assist in the development of project specific details. Details may be modified where necessary to accommodate job specific requirements but must be approved by Equus Industries Ltd. All components must be supplied by Equus Industries Ltd. Equus reserves the right to alter or upgrade details at any time without prior notice.</small></p>						

- ① Metal Roof Deck
- ② EQUUS Colphene 3000 Vapour Barrier
- ③ EQUUS SOPRAROCK mineral wool thermal insulation
- ④ EQUUS SOPRASUN PLUS 3 base sheet
- ⑤ EQUUS SOPRASUN PLUS MINERAL cap sheet

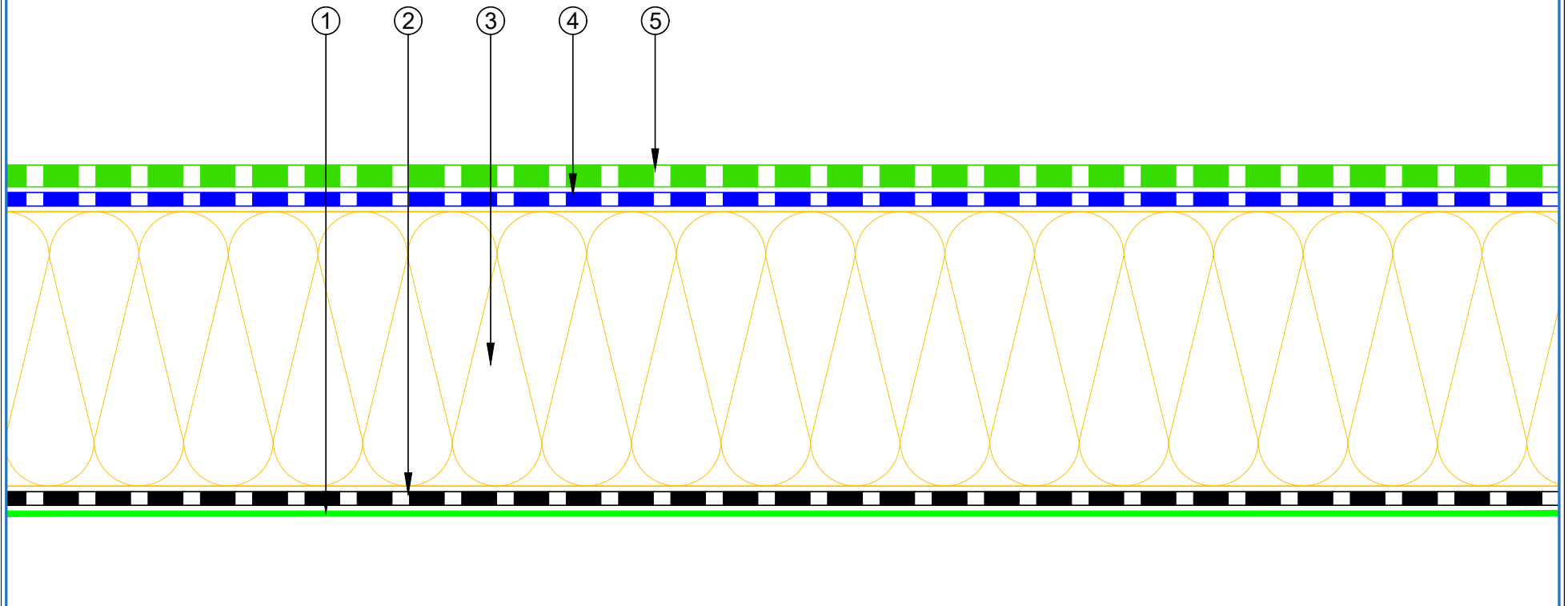

 E-mail : admin@equus.co.nz Web : www.equus.co.nz	PROJECT :		Warm Roof on Metal Standard Detail - SOPRASUN			
	TITLE :		Roof build up with Mineral wool insulation			
	NUMBER :		SSWRM-D0c	SCALE :	1 : 1	
	DRAWN BY :		NKT	DATE :	29-Aug-2022	REVISED :
	<p>Equus Waterproof Membrane Details are specially drawn for use by Local Authorities, Building Contractors, Equus Applicators, Architects and design professionals. All details are drawn to assist in the development of project specific details. Details may be modified where necessary to accommodate job specific requirements but must be approved by Equus Industries Ltd. All components must be supplied by Equus Industries Ltd. Equus reserves the right to alter or upgrade details at any time without prior notice.</p>					

- ① Metal Roof Deck
- ② EQUUS Colphene 3000 Vapour Barrier
- ③ EQUUS SOPRAROCK mineral wool thermal insulation
- ④ EQUUS Permabase Dek roof cover board
- ⑤ EQUUS Sopradere Quick primer
- ⑥ EQUUS SOPRASUN PLUS 3 base sheet
- ⑦ EQUUS SOPRASUN PLUS MINERAL cap sheet

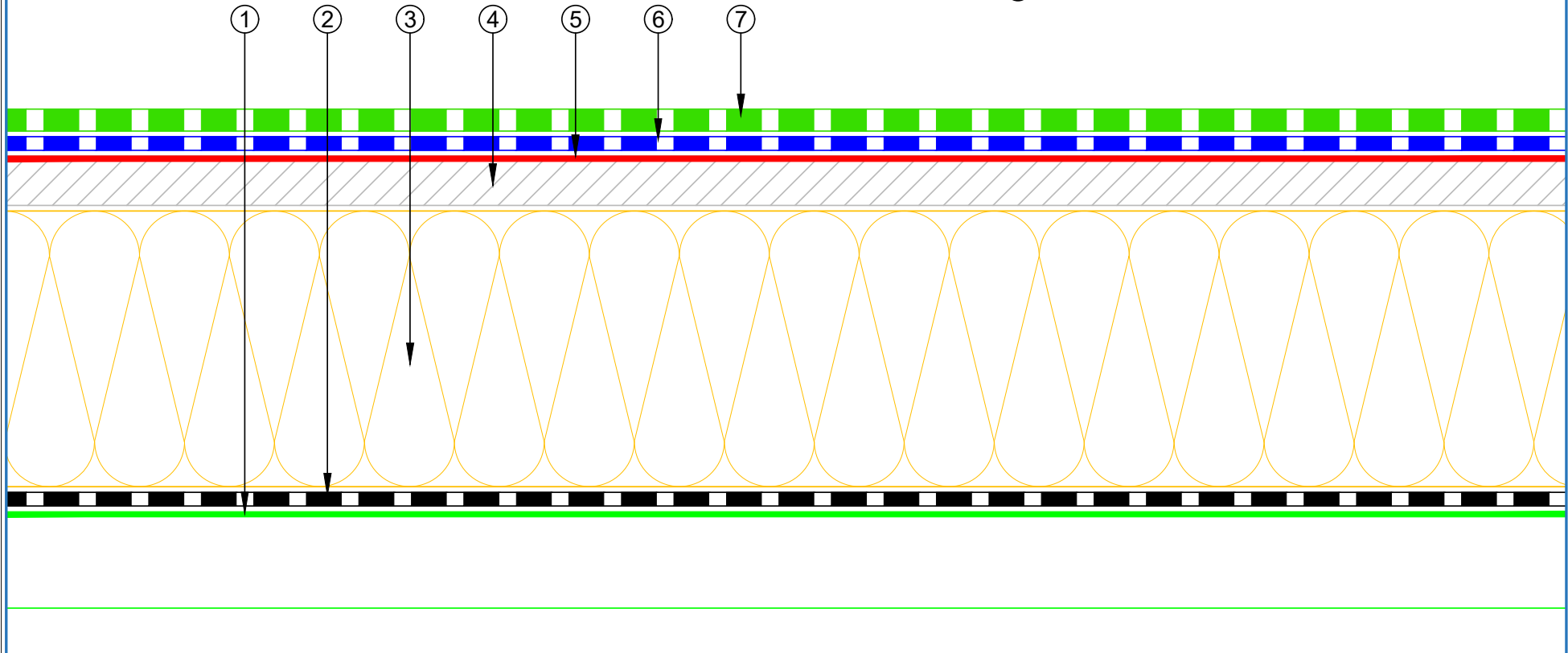

 E-mail : admin@equus.co.nz Web : www.equus.co.nz	PROJECT :	Warm Roof on Metal Standard Detail - SOPRASUN			 AUTHORISED DISTRIBUTOR SOPREMA
	TITLE :	Roof build up with Mineral wool insulation and Roof board			
	NUMBER :	SSWRM-D0d	SCALE :	1 : 1	
	DRAWN BY :	NKT	DATE :	29-Aug-2022	
			REVISED :		
<p><small>Equus Waterproof Membrane Details are specially drawn for use by Local Authorities, Building Contractors, Equus Applicators, Architects and design professionals. All details are drawn to assist in the development of project specific details. Details may be modified where necessary to accommodate job specific requirements but must be approved by Equus Industries Ltd. All components must be supplied by Equus Industries Ltd. Equus reserves the right to alter or upgrade details at any time without prior notice.</small></p>					

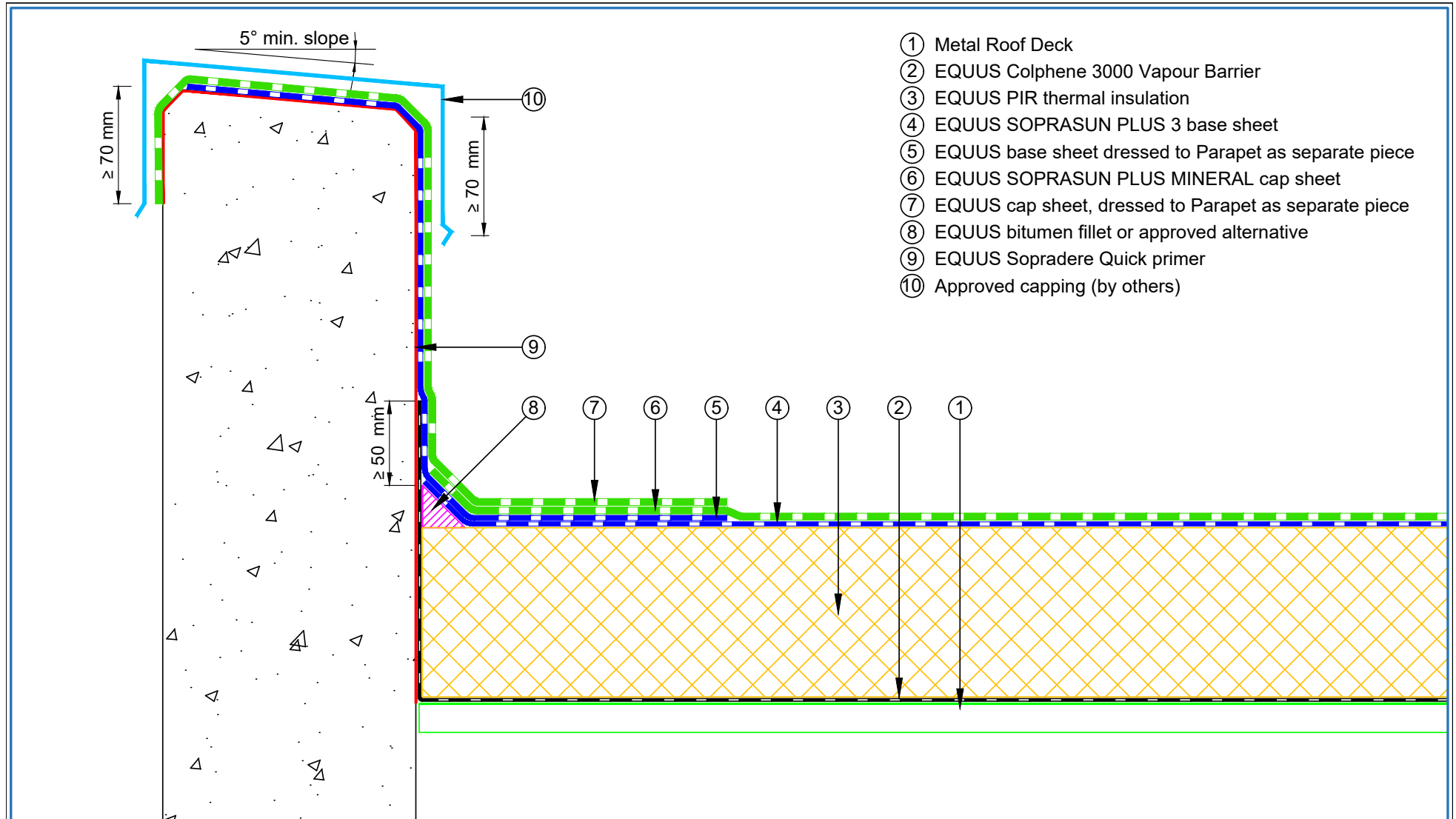

- ① Metal Roof Deck
- ② EQUUS Colphene 3000 Vapour Barrier
- ③ EQUUS PIR thermal insulation
- ④ EQUUS SOPRASUN PLUS 3 base sheet
- ⑤ EQUUS base sheet dressed to Parapet as separate piece
- ⑥ EQUUS SOPRASUN PLUS MINERAL cap sheet
- ⑦ EQUUS cap sheet, dressed to Parapet as separate piece
- ⑧ EQUUS bitumen fillet or approved alternative
- ⑨ EQUUS Sopradere Quick primer
- ⑩ Approved capping (by others)

 E-mail : admin@equus.co.nz Web : www.equus.co.nz	PROJECT :		Warm Roof on Metal Standard Detail - SOPRASUN			
	TITLE :		Concrete parapet detail with roof cap flashing (PIR insulation)			
	NUMBER :		SSWRM-D1a	SCALE :		1 : 3
	DRAWN BY :	NKT	DATE :	29-Aug-2022		REVISED :
	Equus Waterproof Membrane Details are specially drawn for use by Local Authorities, Building Contractors, Equus Applicators, Architects and design professionals. All details are drawn to assist in the development of project specific details. Details may be modified where necessary to accommodate job specific requirements but must be approved by Equus Industries Ltd. All components must be supplied by Equus Industries Ltd. Equus reserves the right to alter or upgrade details at any time without prior notice.					

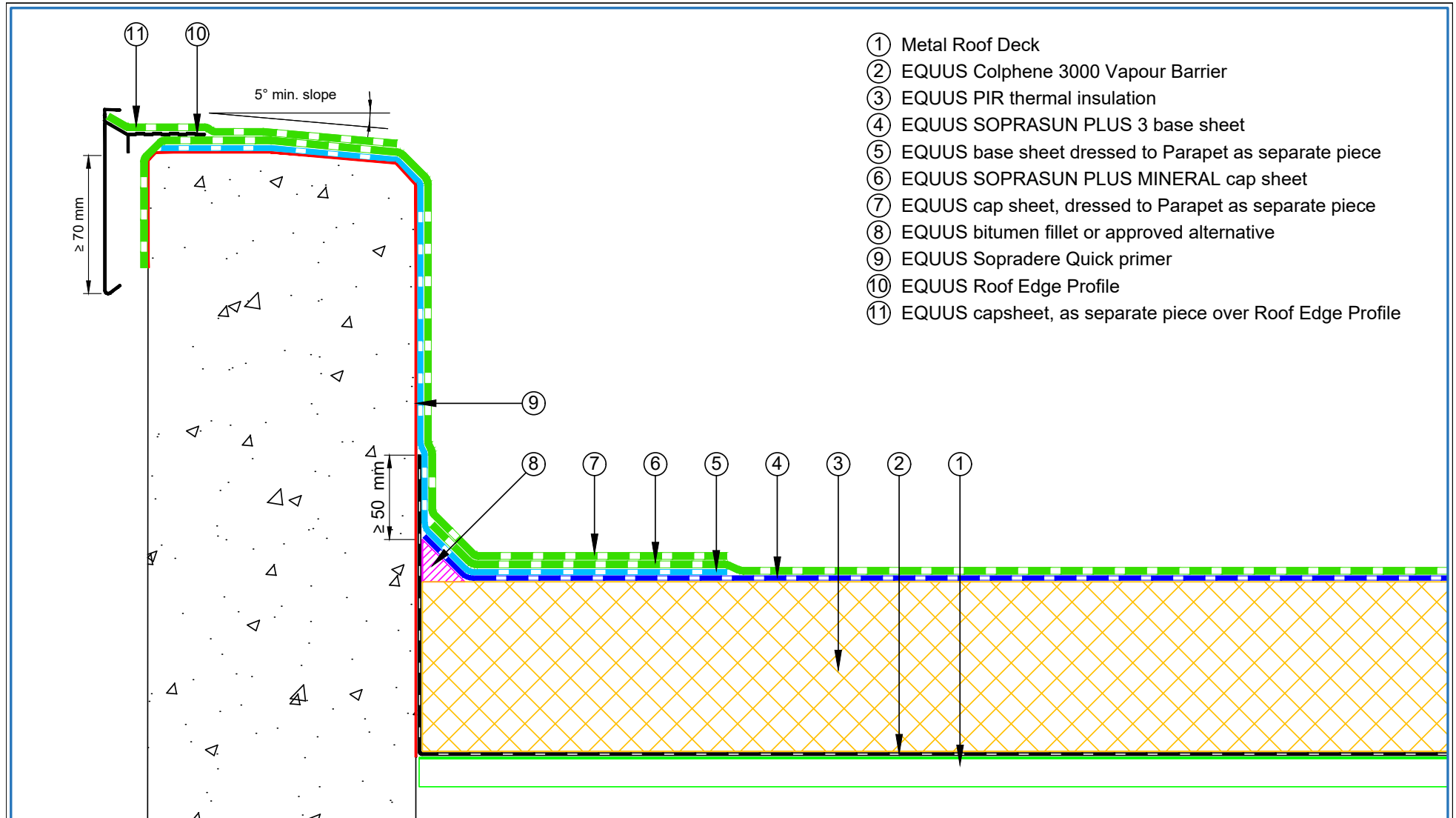

- ① Metal Roof Deck
- ② EQUUS Colphene 3000 Vapour Barrier
- ③ EQUUS PIR thermal insulation
- ④ EQUUS SOPRASUN PLUS 3 base sheet
- ⑤ EQUUS base sheet dressed to Parapet as separate piece
- ⑥ EQUUS SOPRASUN PLUS MINERAL cap sheet
- ⑦ EQUUS cap sheet, dressed to Parapet as separate piece
- ⑧ EQUUS bitumen fillet or approved alternative
- ⑨ EQUUS Sopradere Quick primer
- ⑩ EQUUS Roof Edge Profile
- ⑪ EQUUS capsheet, as separate piece over Roof Edge Profile

E-mail : admin@equus.co.nz
Web : www.equus.co.nz

PROJECT :	Warm Roof on Metal Standard Detail - SOPRASUN		
TITLE :	Concrete parapet detail with roof edge profile (PIR insulation)		
NUMBER :	SSWRM-D1b	SCALE :	1 : 3
DRAWN BY :	NKT	DATE :	29-Aug-2022
		REVISED :	
<p><small>Equus Waterproof Membrane Details are specially drawn for use by Local Authorities, Building Contractors, Equus Applicators, Architects and design professionals. All details are drawn to assist in the development of project specific details. Details may be modified where necessary to accommodate job specific requirements but must be approved by Equus Industries Ltd. All components must be supplied by Equus Industries Ltd. Equus reserves the right to alter or upgrade details at any time without prior notice.</small></p>			

AUTHORISED DISTRIBUTOR
SOPREMA

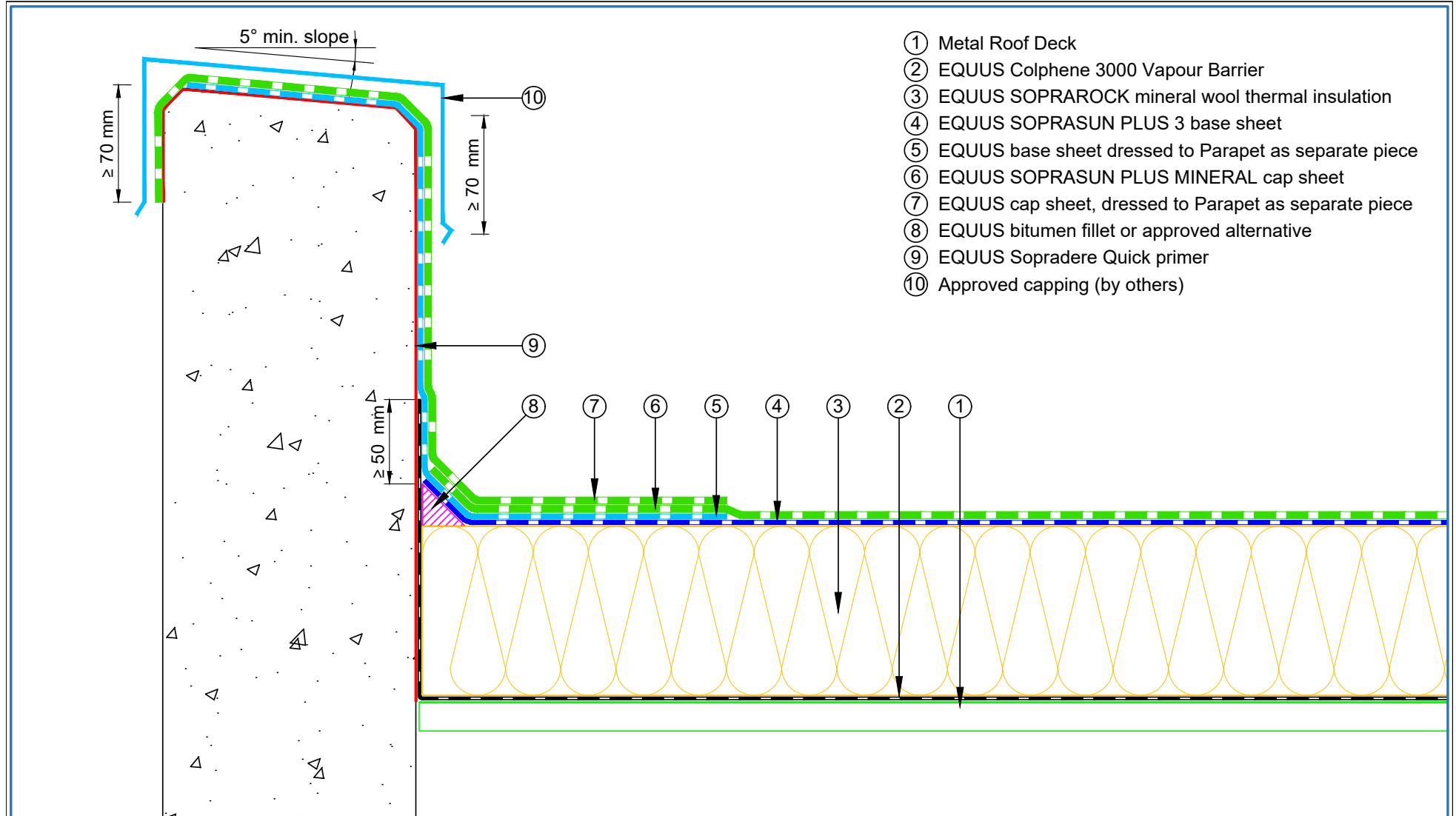

- ① Metal Roof Deck
- ② EQUUS Colphene 3000 Vapour Barrier
- ③ EQUUS SOPRAROCK mineral wool thermal insulation
- ④ EQUUS SOPRASUN PLUS 3 base sheet
- ⑤ EQUUS base sheet dressed to Parapet as separate piece
- ⑥ EQUUS SOPRASUN PLUS MINERAL cap sheet
- ⑦ EQUUS cap sheet, dressed to Parapet as separate piece
- ⑧ EQUUS bitumen fillet or approved alternative
- ⑨ EQUUS Sopradere Quick primer
- ⑩ Approved capping (by others)

 E-mail : admin@equus.co.nz Web : www.equus.co.nz	PROJECT :		Warm Roof on Metal Standard Detail - SOPRASUN	
	TITLE :		Concrete parapet detail with roof cap flashing (Mineral wool insulation)	
	NUMBER :	SSWRM-D1c	SCALE :	1 : 3
	DRAWN BY :	NKT	DATE :	29-Aug-2022
			REVISED :	
<p><small>Equus Waterproof Membrane Details are specially drawn for use by Local Authorities, Building Contractors, Equus Applicators, Architects and design professionals. All details are drawn to assist in the development of project specific details. Details may be modified where necessary to accommodate job specific requirements but must be approved by Equus Industries Ltd. All components must be supplied by Equus Industries Ltd. Equus reserves the right to alter or upgrade details at any time without prior notice.</small></p>				

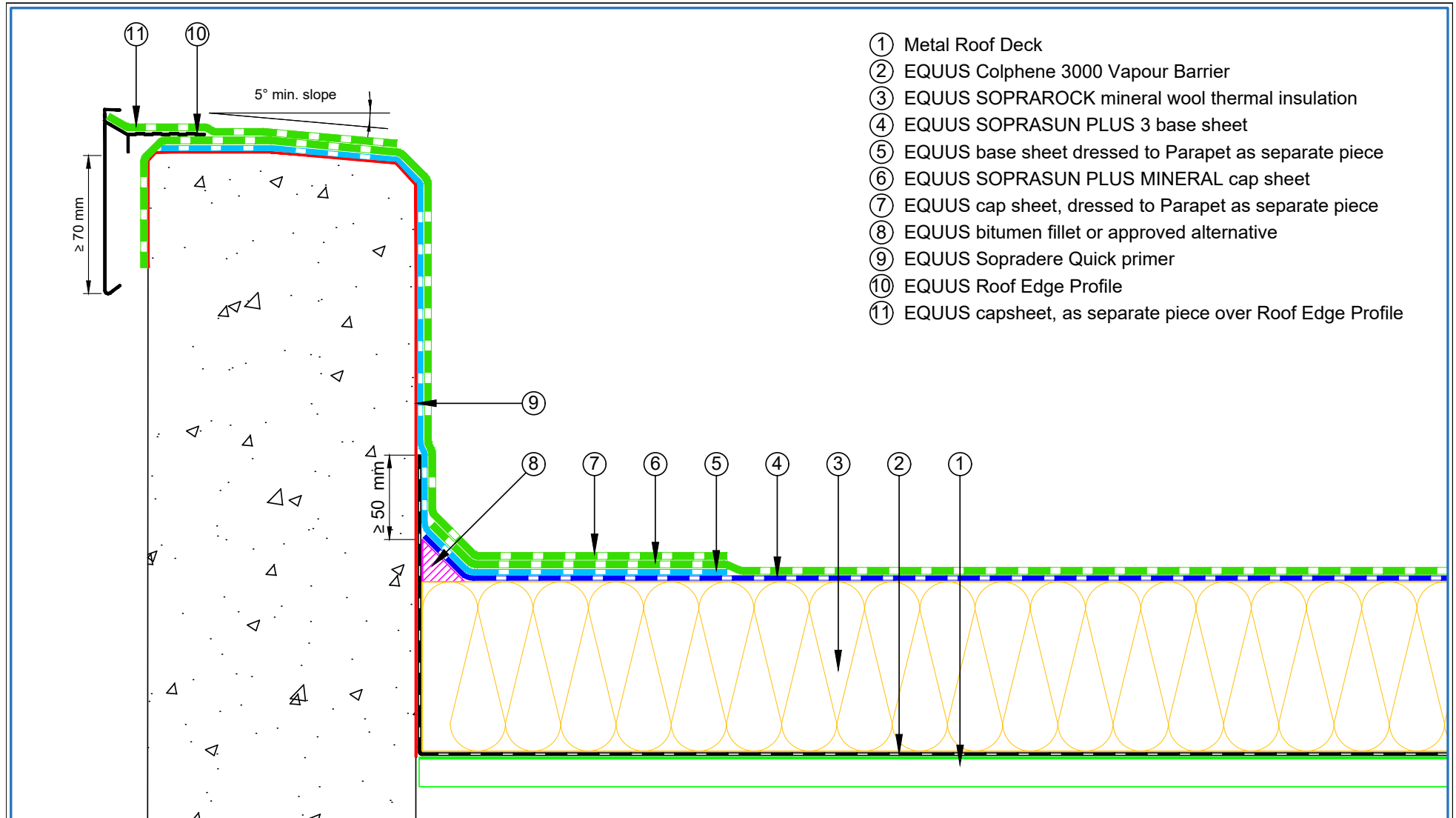

- ① Metal Roof Deck
- ② EQUUS Colphene 3000 Vapour Barrier
- ③ EQUUS SOPRAROCK mineral wool thermal insulation
- ④ EQUUS SOPRASUN PLUS 3 base sheet
- ⑤ EQUUS base sheet dressed to Parapet as separate piece
- ⑥ EQUUS SOPRASUN PLUS MINERAL cap sheet
- ⑦ EQUUS cap sheet, dressed to Parapet as separate piece
- ⑧ EQUUS bitumen fillet or approved alternative
- ⑨ EQUUS Sopradere Quick primer
- ⑩ EQUUS Roof Edge Profile
- ⑪ EQUUS capsheet, as separate piece over Roof Edge Profile

E-mail : admin@equus.co.nz
Web : www.equus.co.nz

PROJECT :	Warm Roof on Metal Standard Detail - SOPRASUN		
TITLE :	Concrete parapet detail with roof edge profile (Mineral wool insulation)		
NUMBER :	SSWRM-D1d	SCALE :	1 : 3
DRAWN BY :	NKT	DATE :	29-Aug-2022
REVISD :			

Equus Waterproof Membrane Details are specially drawn for use by Local Authorities, Building Contractors, Equus Applicators, Architects and design professionals. All details are drawn to assist in the development of project specific details. Details may be modified where necessary to accommodate job specific requirements but must be approved by Equus Industries Ltd. All components must be supplied by Equus Industries Ltd. Equus reserves the right to alter or upgrade details at any time without prior notice.

AUTHORISED DISTRIBUTOR
SOPREMA

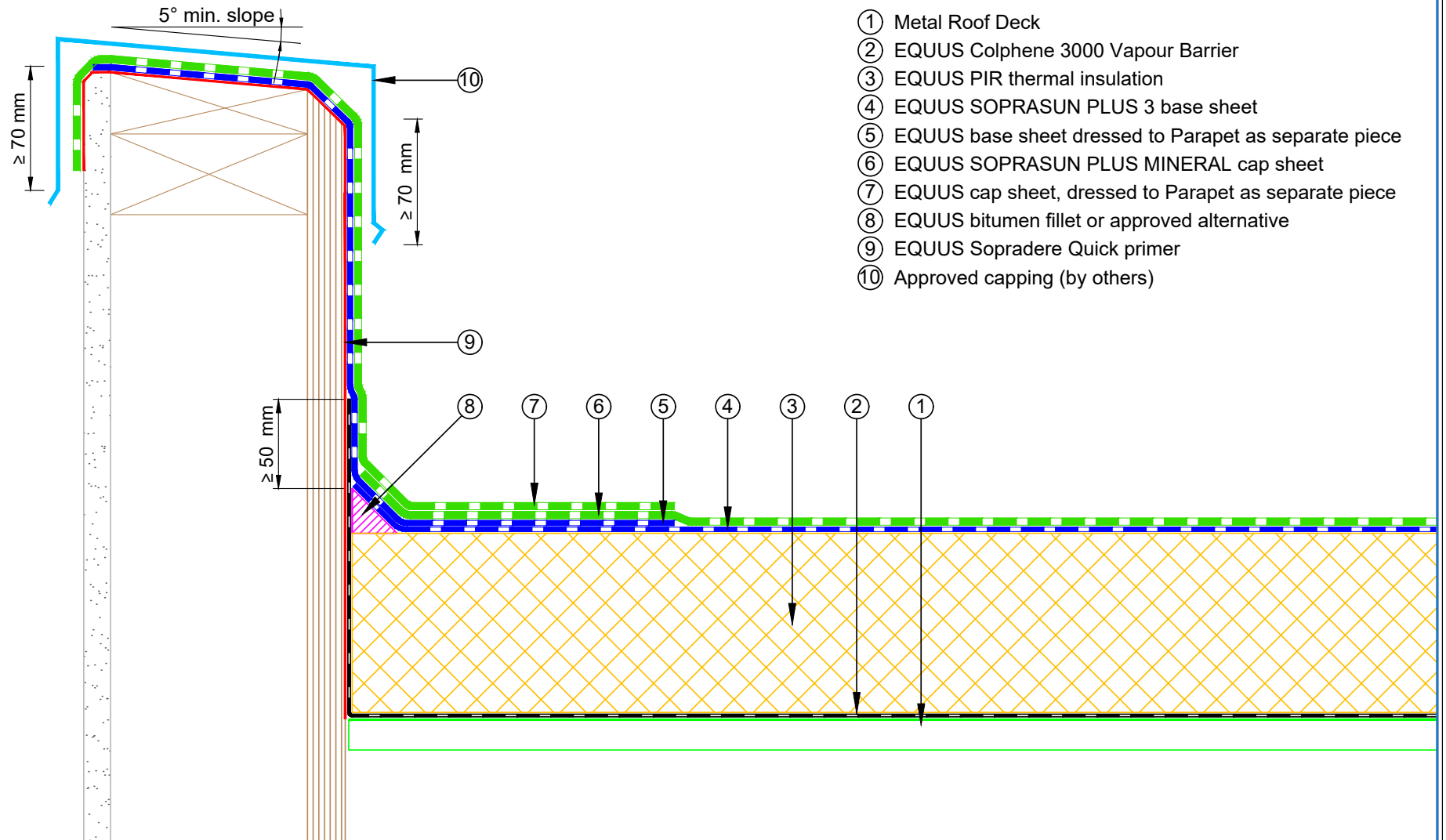

- ① Metal Roof Deck
- ② EQUUS Colphene 3000 Vapour Barrier
- ③ EQUUS PIR thermal insulation
- ④ EQUUS SOPRASUN PLUS 3 base sheet
- ⑤ EQUUS base sheet dressed to Parapet as separate piece
- ⑥ EQUUS SOPRASUN PLUS MINERAL cap sheet
- ⑦ EQUUS cap sheet, dressed to Parapet as separate piece
- ⑧ EQUUS bitumen fillet or approved alternative
- ⑨ EQUUS Sopradere Quick primer
- ⑩ Approved capping (by others)

PROJECT :	Warm Roof on Metal Standard Detail - SOPRASUN		
TITLE :	Plywood parapet detail with roof cap flashing (PIR insulation)		
NUMBER :	SSWRM-D2a	SCALE :	1 : 3
DRAWN BY :	NKT	DATE :	29-Aug-2022
		REVISED :	
<p><small>Equus Waterproof Membrane Details are specially drawn for use by Local Authorities, Building Contractors, Equus Applicators, Architects and design professionals. All details are drawn to assist in the development of project specific details. Details may be modified where necessary to accommodate job specific requirements but must be approved by Equus Industries Ltd. All components must be supplied by Equus Industries Ltd. Equus reserves the right to alter or upgrade details at any time without prior notice.</small></p>			

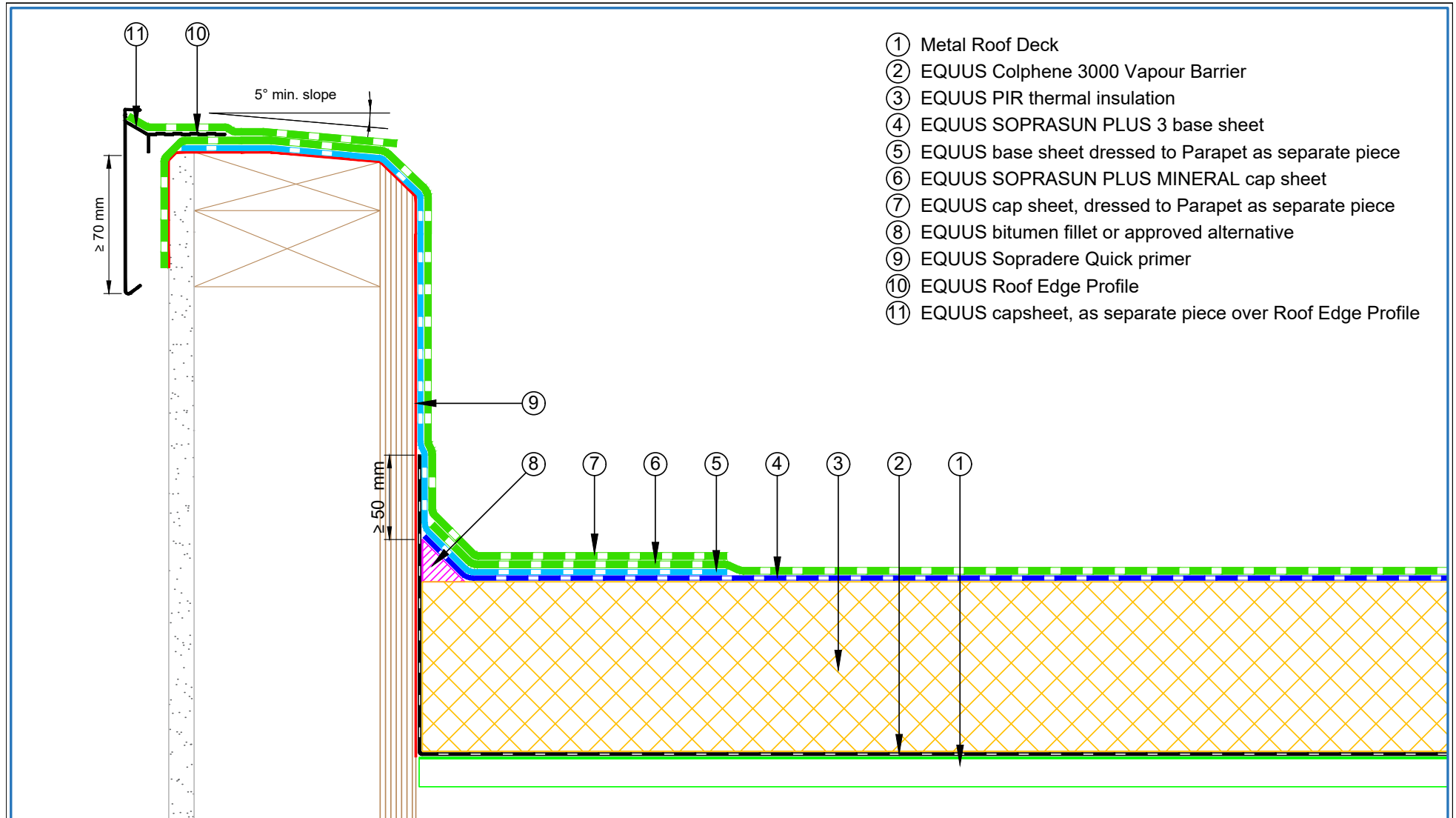

- ① Metal Roof Deck
- ② EQUUS Colphene 3000 Vapour Barrier
- ③ EQUUS PIR thermal insulation
- ④ EQUUS SOPRASUN PLUS 3 base sheet
- ⑤ EQUUS base sheet dressed to Parapet as separate piece
- ⑥ EQUUS SOPRASUN PLUS MINERAL cap sheet
- ⑦ EQUUS cap sheet, dressed to Parapet as separate piece
- ⑧ EQUUS bitumen fillet or approved alternative
- ⑨ EQUUS Sopradere Quick primer
- ⑩ EQUUS Roof Edge Profile
- ⑪ EQUUS capsheet, as separate piece over Roof Edge Profile

<p>E-mail : admin@equus.co.nz Web : www.equus.co.nz</p>	PROJECT :		Warm Roof on Metal Standard Detail - SOPRASUN		
	TITLE :		Plywood parapet detail with roof edge profile (PIR insulation)		
	NUMBER :		SSWRM-D2b	SCALE :	1 : 3
	DRAWN BY :	NKT	DATE :	29-Aug-2022	REVISED :
	<p>Equis Waterproof Membrane Details are specially drawn for use by Local Authorities, Building Contractors, Equis Applicators, Architects and design professionals. All details are drawn to assist in the development of project specific details. Details may be modified where necessary to accommodate job specific requirements but must be approved by Equis Industries Ltd. All components must be supplied by Equis Industries Ltd. Equis reserves the right to alter or upgrade details at any time without prior notice.</p>				



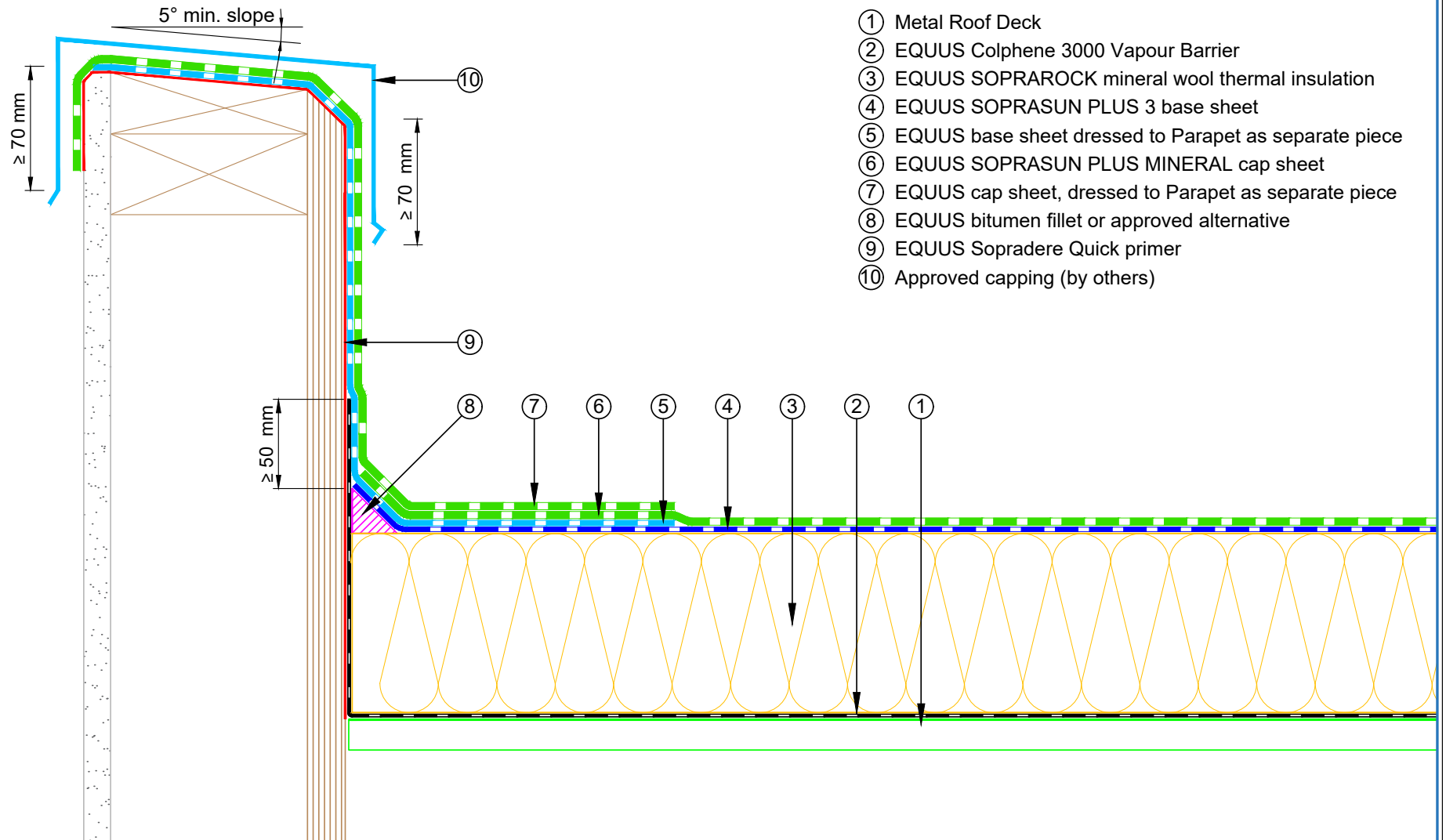

PROJECT :	Warm Roof on Metal Standard Detail - SOPRASUN		
TITLE :	Plywood parapet detail with roof cap flashing (Mineral wool insulation)		
NUMBER :	SSWRM-D2c	SCALE :	1 : 3
DRAWN BY :	NKT	DATE :	29-Aug-2022
		REVISED :	
<p><small>Equus Waterproof Membrane Details are specially drawn for use by Local Authorities, Building Contractors, Equus Applicators, Architects and design professionals. All details are drawn to assist in the development of project specific details. Details may be modified where necessary to accommodate job specific requirements but must be approved by Equus Industries Ltd. All components must be supplied by Equus Industries Ltd. Equus reserves the right to alter or upgrade details at any time without prior notice.</small></p>			

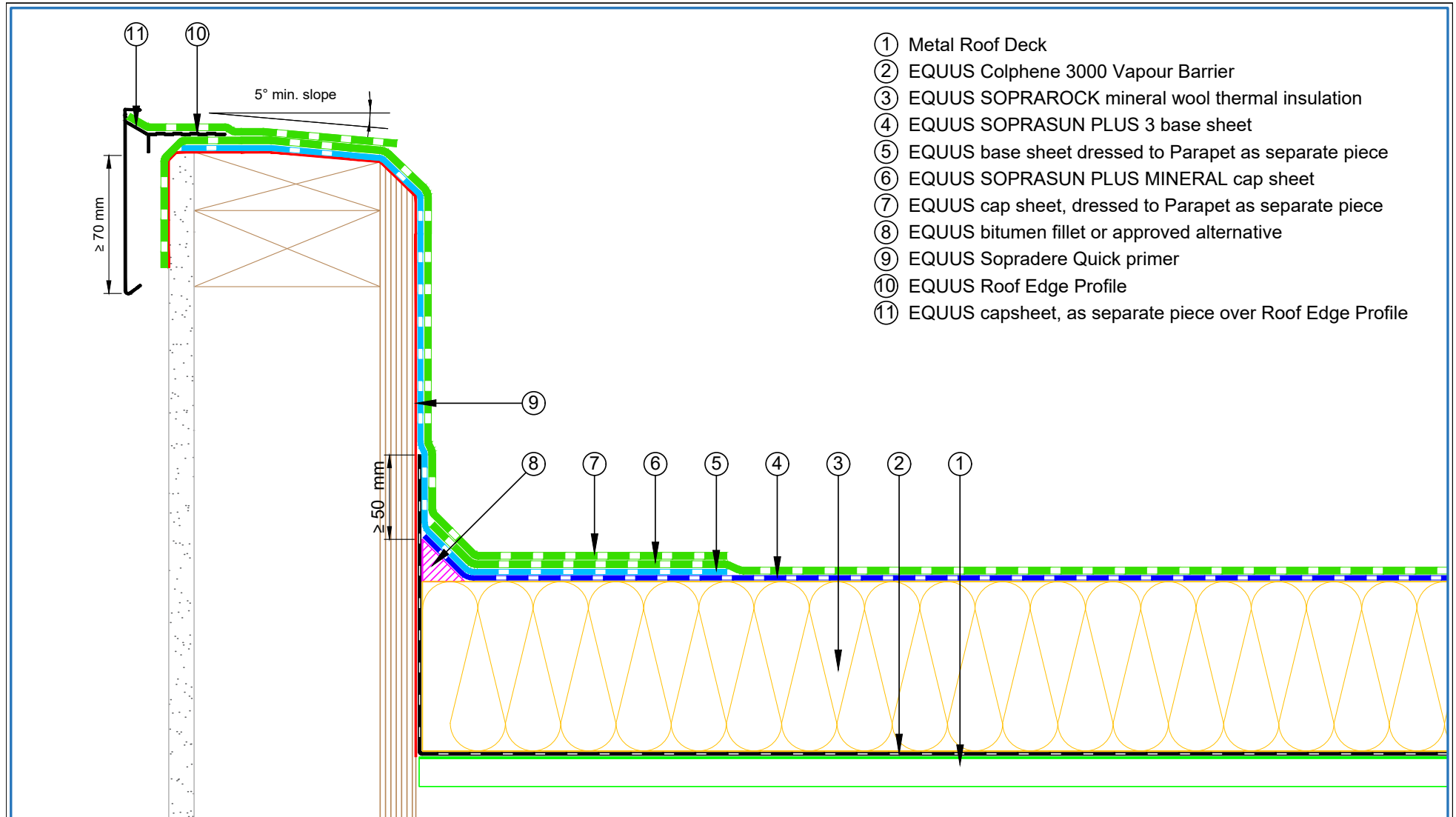

- ① Metal Roof Deck
- ② EQUUS Colphene 3000 Vapour Barrier
- ③ EQUUS SOPRAROCK mineral wool thermal insulation
- ④ EQUUS SOPRASUN PLUS 3 base sheet
- ⑤ EQUUS base sheet dressed to Parapet as separate piece
- ⑥ EQUUS SOPRASUN PLUS MINERAL cap sheet
- ⑦ EQUUS cap sheet, dressed to Parapet as separate piece
- ⑧ EQUUS bitumen fillet or approved alternative
- ⑨ EQUUS Sopradere Quick primer
- ⑩ EQUUS Roof Edge Profile
- ⑪ EQUUS capsheet, as separate piece over Roof Edge Profile

<p>E-mail : admin@equus.co.nz Web : www.equus.co.nz</p>	PROJECT :		Warm Roof on Metal Standard Detail - SOPRASUN		<p>AUTHORISED DISTRIBUTOR SOPREMA</p>	
	TITLE :		Plywood parapet detail with roof edge profile (Mineral wool insulation)			
	NUMBER :		SSWRM-D2d	SCALE :		1 : 3
	DRAWN BY :		NKT	DATE :		29-Aug-2022
				REVISED :		
<p><small>Equus Waterproof Membrane Details are specially drawn for use by Local Authorities, Building Contractors, Equus Applicators, Architects and design professionals. All details are drawn to assist in the development of project specific details. Details may be modified where necessary to accommodate job specific requirements but must be approved by Equus Industries Ltd. All components must be supplied by Equus Industries Ltd. Equus reserves the right to alter or upgrade details at any time without prior notice.</small></p>						

- ① Metal Roof Deck
- ② EQUUS Colphene 3000 Vapour Barrier
- ③ EQUUS PIR thermal insulation
- ④ Plywood
- ⑤ EQUUS Sopradere Quick primer
- ⑥ EQUUS SOPRASUN PLUS 3 base sheet
- ⑦ EQUUS SOPRASUN PLUS MINERAL cap sheet
- ⑧ Allproof dome clamp ring drain

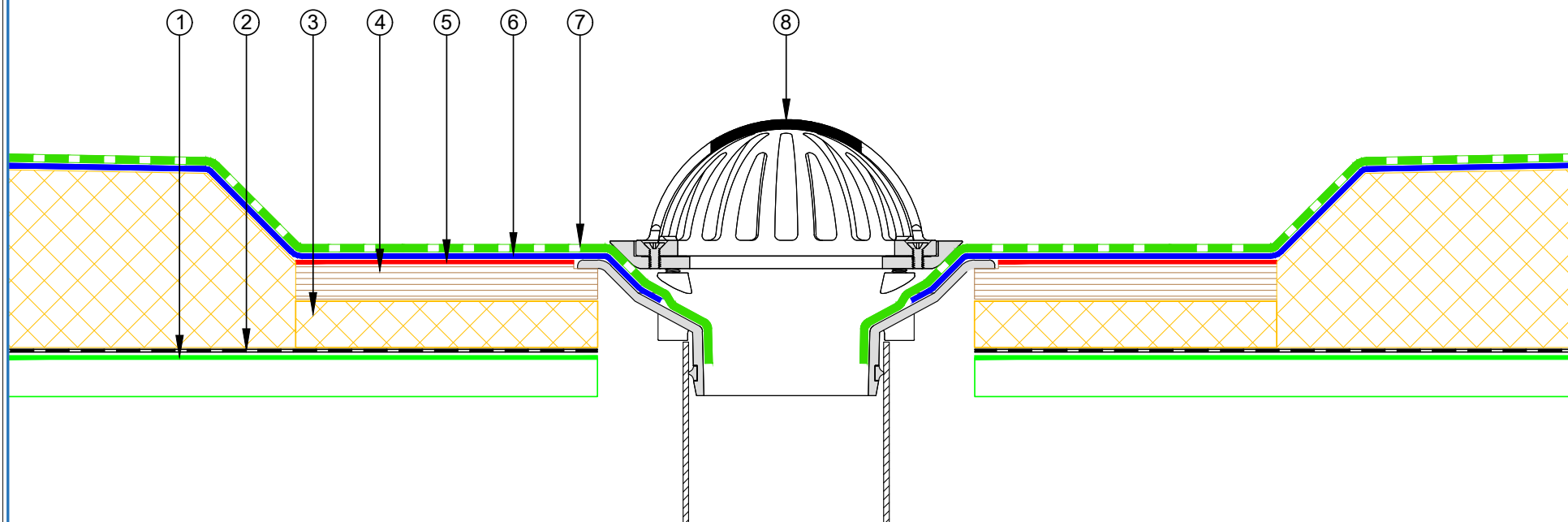

 E-mail : admin@equus.co.nz Web : www.equus.co.nz	PROJECT :		Warm Roof on Metal Standard Detail - SOPRASUN		 AUTHORISED DISTRIBUTOR SOPREMA
	TITLE :		Allproof dome clamp ring drain		
	NUMBER :	SSWRM-D3a	SCALE :	1 : 3	
	DRAWN BY :	NKT	DATE :	29-Aug-2022	
	REVISD :				
<p><small>Equus Waterproof Membrane Details are specially drawn for use by Local Authorities, Building Contractors, Equus Applicators, Architects and design professionals. All details are drawn to assist in the development of project specific details. Details may be modified where necessary to accommodate job specific requirements but must be approved by Equus Industries Ltd. All components must be supplied by Equus Industries Ltd. Equus reserves the right to alter or upgrade details at any time without prior notice.</small></p>					

- ① Metal Roof Deck
- ② EQUUS Colphene 3000 Vapour Barrier
- ③ EQUUS PIR thermal insulation
- ④ Plywood
- ⑤ EQUUS Sopradere Quick primer
- ⑥ EQUUS SOPRASUN PLUS 3 base sheet
- ⑦ EQUUS SOPRASUN PLUS MINERAL cap sheet
- ⑧ Aquaknight HiFlow roof drain

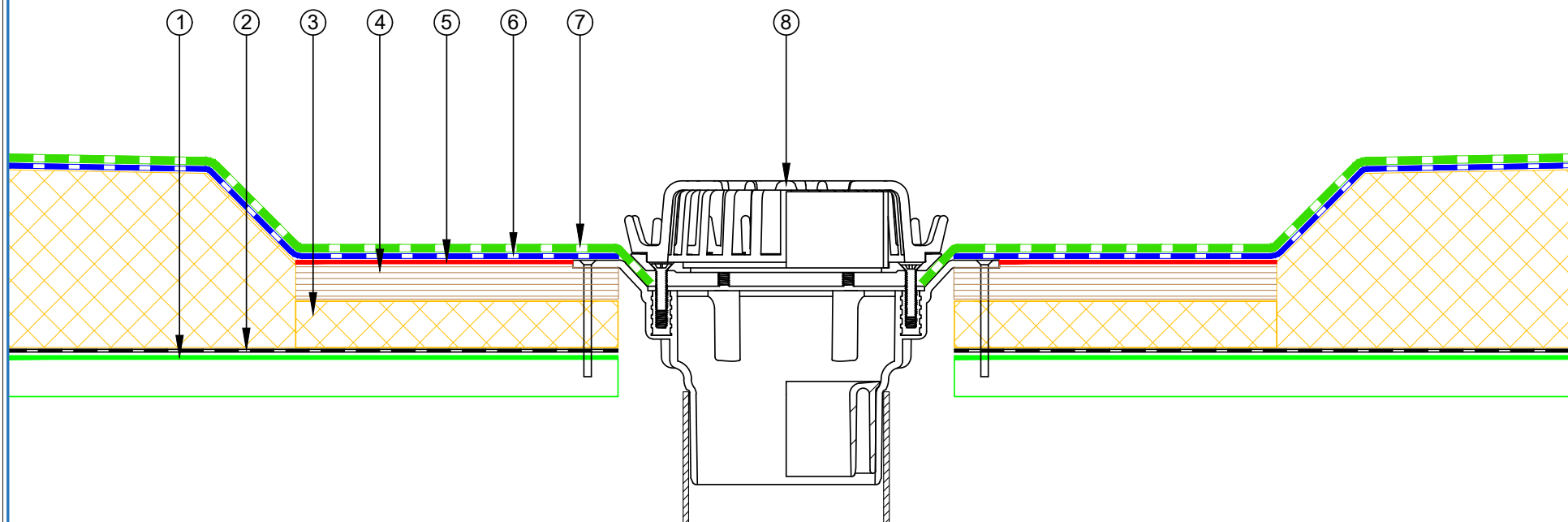

E-mail : admin@equus.co.nz
Web : www.equus.co.nz

PROJECT :	Warm Roof on Metal Standard Detail - SOPRASUN		
TITLE :	Aquaknight HiFlow roof drain		
NUMBER :	SSWRM-D3b	SCALE :	1 : 3
DRAWN BY :	NKT	DATE :	29-Aug-2022
		REVISED :	

Equus Waterproof Membrane Details are specially drawn for use by Local Authorities, Building Contractors, Equus Applicators, Architects and design professionals. All details are drawn to assist in the development of project specific details. Details may be modified where necessary to accommodate job specific requirements but must be approved by Equus Industries Ltd. All components must be supplied by Equus Industries Ltd. Equus reserves the right to alter or upgrade details at any time without prior notice.



- ① Metal Roof Deck
- ② EQUUS Colphene 3000 Vapour Barrier
- ③ EQUUS PIR thermal insulation
- ④ Plywood
- ⑤ Sopradere Quick or Aquadere bitumen primer
- ⑥ EQUUS SOPRASUN PLUS 3 base sheet
- ⑦ EQUUS SOPRASUN PLUS MINERAL cap sheet
- ⑧ Allproof dome clamp ring drain 168.80DCR

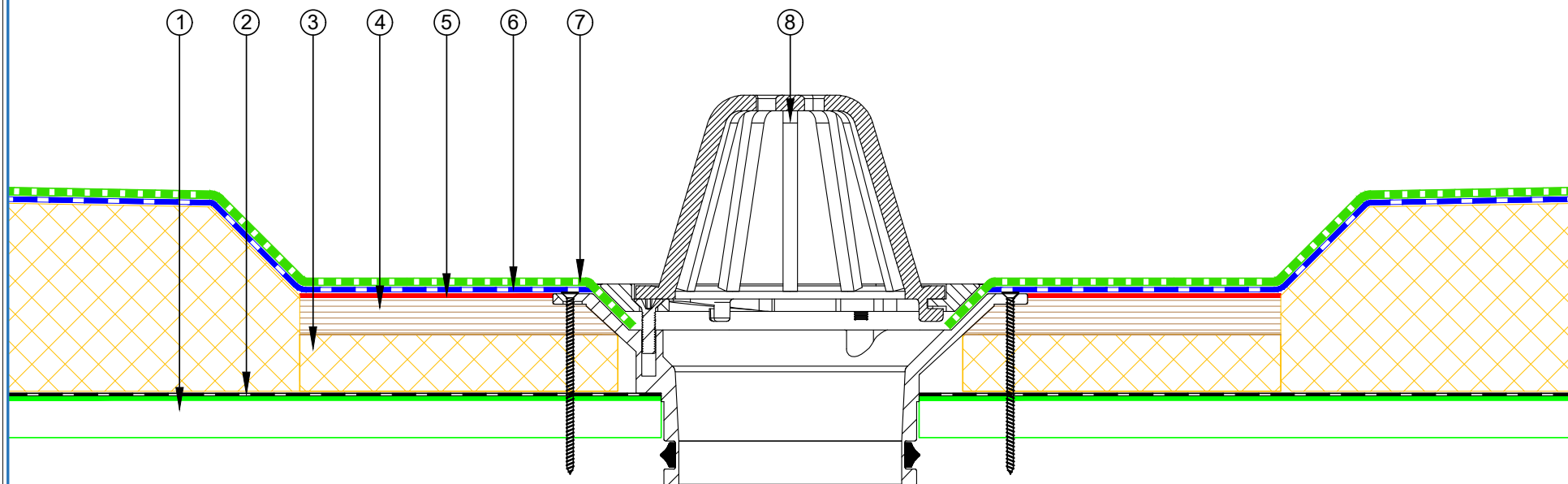

E-mail : admin@equus.co.nz
Web : www.equus.co.nz

PROJECT :	Warm Roof on Metal Standard Detail - SOPRASUN		
TITLE :	Allproof dome clamp ring drain 168.80DCR		
NUMBER :	SSWRM-D3c	SCALE :	NTS
DRAWN BY :	NKT	DATE :	29-Aug-2022
		REVISED :	

Equus Waterproof Membrane Details are specially drawn for use by Local Authorities, Building Contractors, Equus Applicators, Architects and design professionals. All details are drawn to assist in the development of project specific details. Details may be modified where necessary to accommodate job specific requirements but must be approved by Equus Industries Ltd. All components must be supplied by Equus Industries Ltd. Equus reserves the right to alter or upgrade details at any time without prior notice.



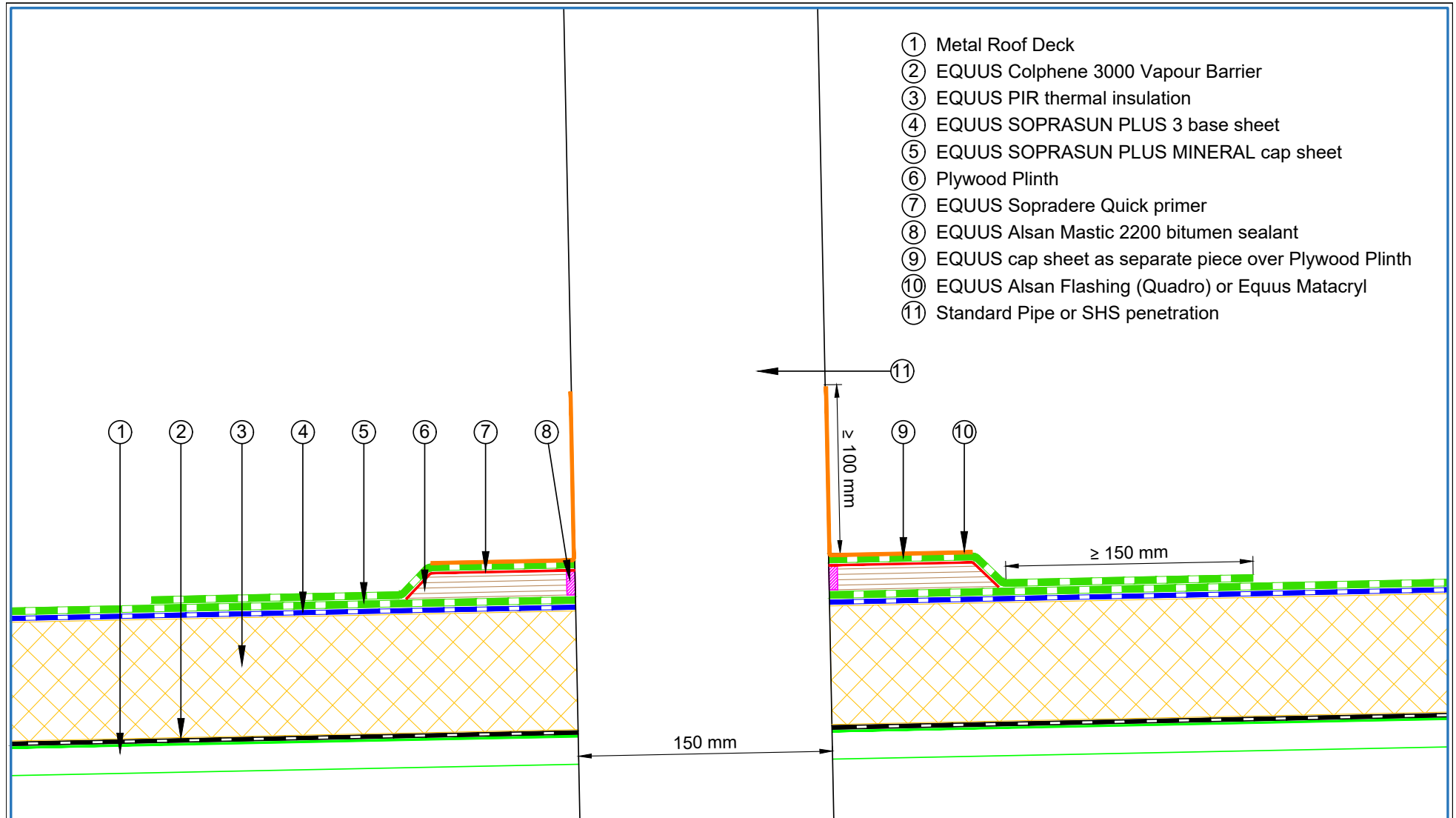

- ① Metal Roof Deck
- ② EQUUS Colphene 3000 Vapour Barrier
- ③ EQUUS PIR thermal insulation
- ④ EQUUS SOPRASUN PLUS 3 base sheet
- ⑤ EQUUS SOPRASUN PLUS MINERAL cap sheet
- ⑥ Plywood Plinth
- ⑦ EQUUS Sopradere Quick primer
- ⑧ EQUUS Alsan Mastic 2200 bitumen sealant
- ⑨ EQUUS cap sheet as separate piece over Plywood Plinth
- ⑩ EQUUS Alsan Flashing (Quadro) or Equus Matacryn
- ⑪ Standard Pipe or SHS penetration

 E-mail : admin@equus.co.nz Web : www.equus.co.nz	PROJECT :		Warm Roof on Metal Standard Detail - SOPRASUN	
	TITLE :		Standard Pipe or SHS penetration (PIR insulation)	
	NUMBER :	SSWRM-D5a	SCALE :	1 : 3
	DRAWN BY :	NKT	DATE :	29-Aug-2022
			REVISED :	
<p><small>Equus Waterproof Membrane Details are specially drawn for use by Local Authorities, Building Contractors, Equus Applicators, Architects and design professionals. All details are drawn to assist in the development of project specific details. Details may be modified where necessary to accommodate job specific requirements but must be approved by Equus Industries Ltd. All components must be supplied by Equus Industries Ltd. Equus reserves the right to alter or upgrade details at any time without prior notice.</small></p>				

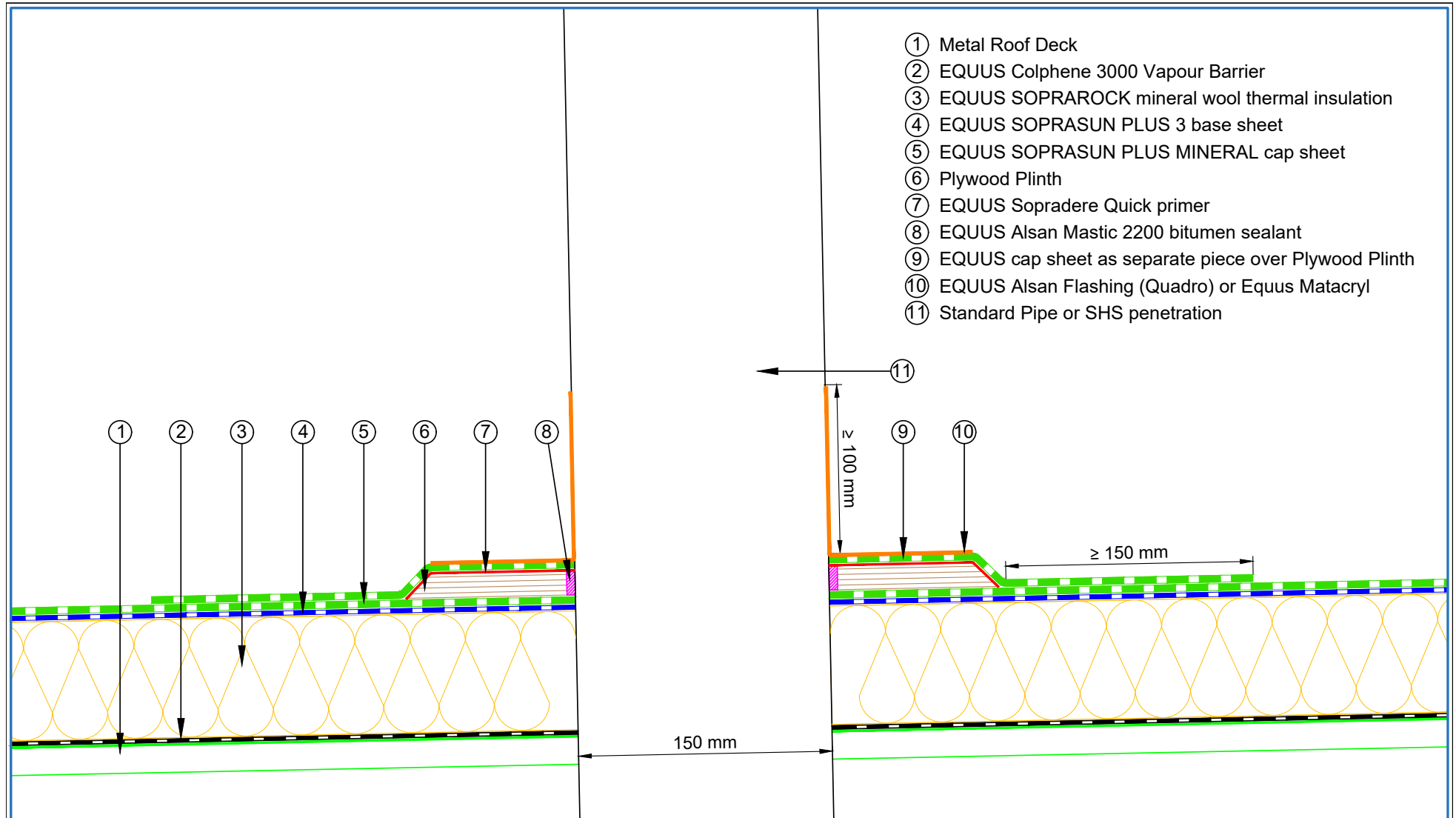

- ① Metal Roof Deck
- ② EQUUS Colphene 3000 Vapour Barrier
- ③ EQUUS SOPRAROCK mineral wool thermal insulation
- ④ EQUUS SOPRASUN PLUS 3 base sheet
- ⑤ EQUUS SOPRASUN PLUS MINERAL cap sheet
- ⑥ Plywood Plinth
- ⑦ EQUUS Sopradere Quick primer
- ⑧ EQUUS Alsan Mastic 2200 bitumen sealant
- ⑨ EQUUS cap sheet as separate piece over Plywood Plinth
- ⑩ EQUUS Alsan Flashing (Quadro) or Equus Matacyl
- ⑪ Standard Pipe or SHS penetration

E-mail : admin@equus.co.nz
Web : www.equus.co.nz

PROJECT :	Warm Roof on Metal Standard Detail - SOPRASUN		
TITLE :	Standard Pipe or SHS penetration (Mineral wool insulation)		
NUMBER :	SSWRM-D5b	SCALE :	1 : 3
DRAWN BY :	NKT	DATE :	29-Aug-2022
		REVISED :	
<p><small>Equus Waterproof Membrane Details are specially drawn for use by Local Authorities, Building Contractors, Equus Applicators, Architects and design professionals. All details are drawn to assist in the development of project specific details. Details may be modified where necessary to accommodate job specific requirements but must be approved by Equus Industries Ltd. All components must be supplied by Equus Industries Ltd. Equus reserves the right to alter or upgrade details at any time without prior notice.</small></p>			

AUTHORISED DISTRIBUTOR
SOPREMA

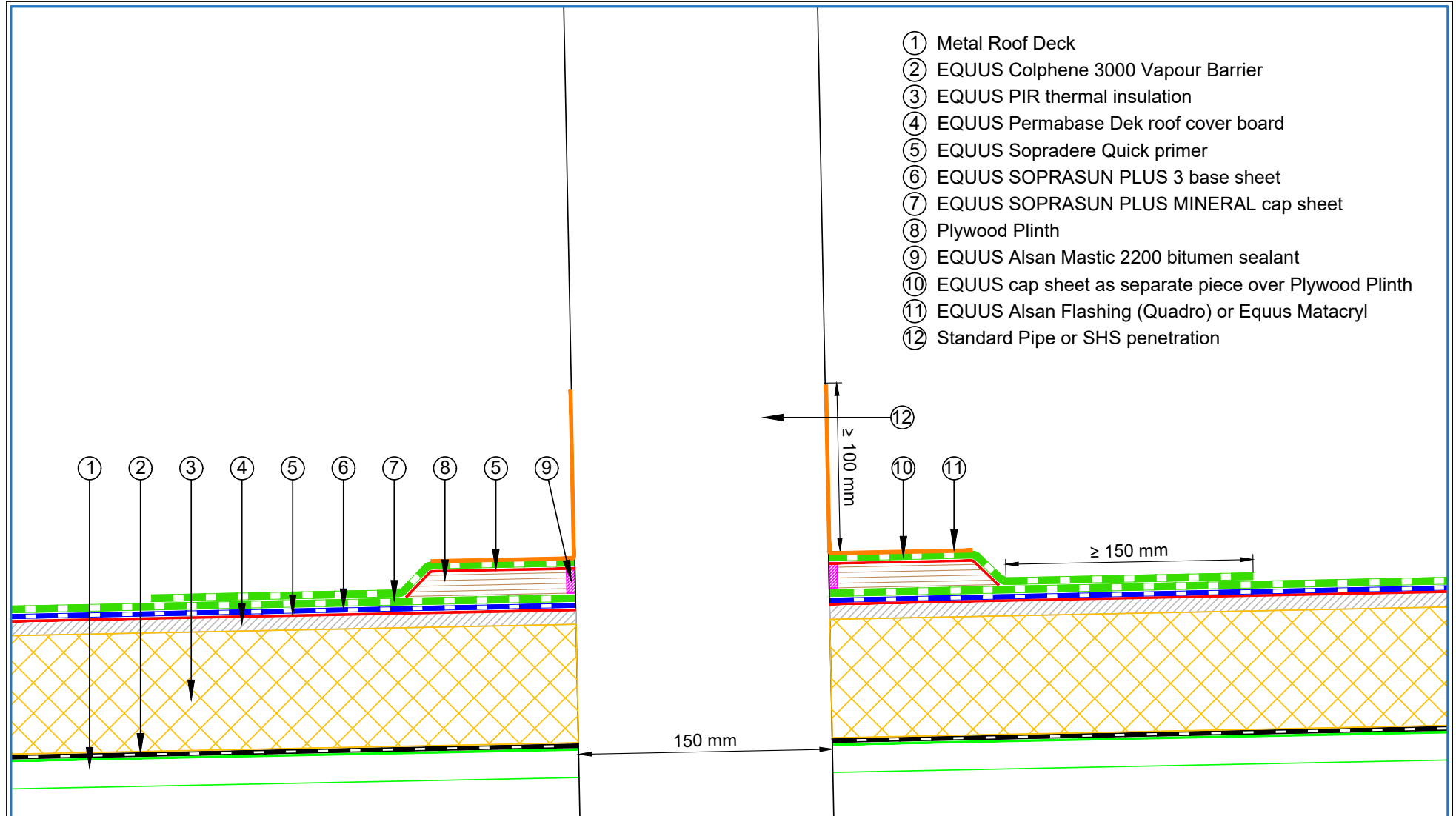

- ① Metal Roof Deck
- ② EQUUS Colphene 3000 Vapour Barrier
- ③ EQUUS PIR thermal insulation
- ④ EQUUS Permabase Dek roof cover board
- ⑤ EQUUS Sopradere Quick primer
- ⑥ EQUUS SOPRASUN PLUS 3 base sheet
- ⑦ EQUUS SOPRASUN PLUS MINERAL cap sheet
- ⑧ Plywood Plinth
- ⑨ EQUUS Alsan Mastic 2200 bitumen sealant
- ⑩ EQUUS cap sheet as separate piece over Plywood Plinth
- ⑪ EQUUS Alsan Flashing (Quadro) or Equus Matacryn
- ⑫ Standard Pipe or SHS penetration

E-mail : admin@equus.co.nz
Web : www.equus.co.nz

PROJECT :	Warm Roof on Metal Standard Detail - SOPRASUN		
TITLE :	Standard Pipe or SHS penetration with cover board (PIR insulation)		
NUMBER :	SSWRM-D5c	SCALE :	1 : 3
DRAWN BY :	NKT	DATE :	29-Aug-2022
<p><small>Equus Waterproof Membrane Details are specially drawn for use by Local Authorities, Building Contractors, Equus Applicators, Architects and design professionals. All details are drawn to assist in the development of project specific details. Details may be modified where necessary to accommodate job specific requirements but must be approved by Equus Industries Ltd. All components must be supplied by Equus Industries Ltd. Equus reserves the right to alter or upgrade details at any time without prior notice.</small></p>			

AUTHORISED DISTRIBUTOR
SOPREMA

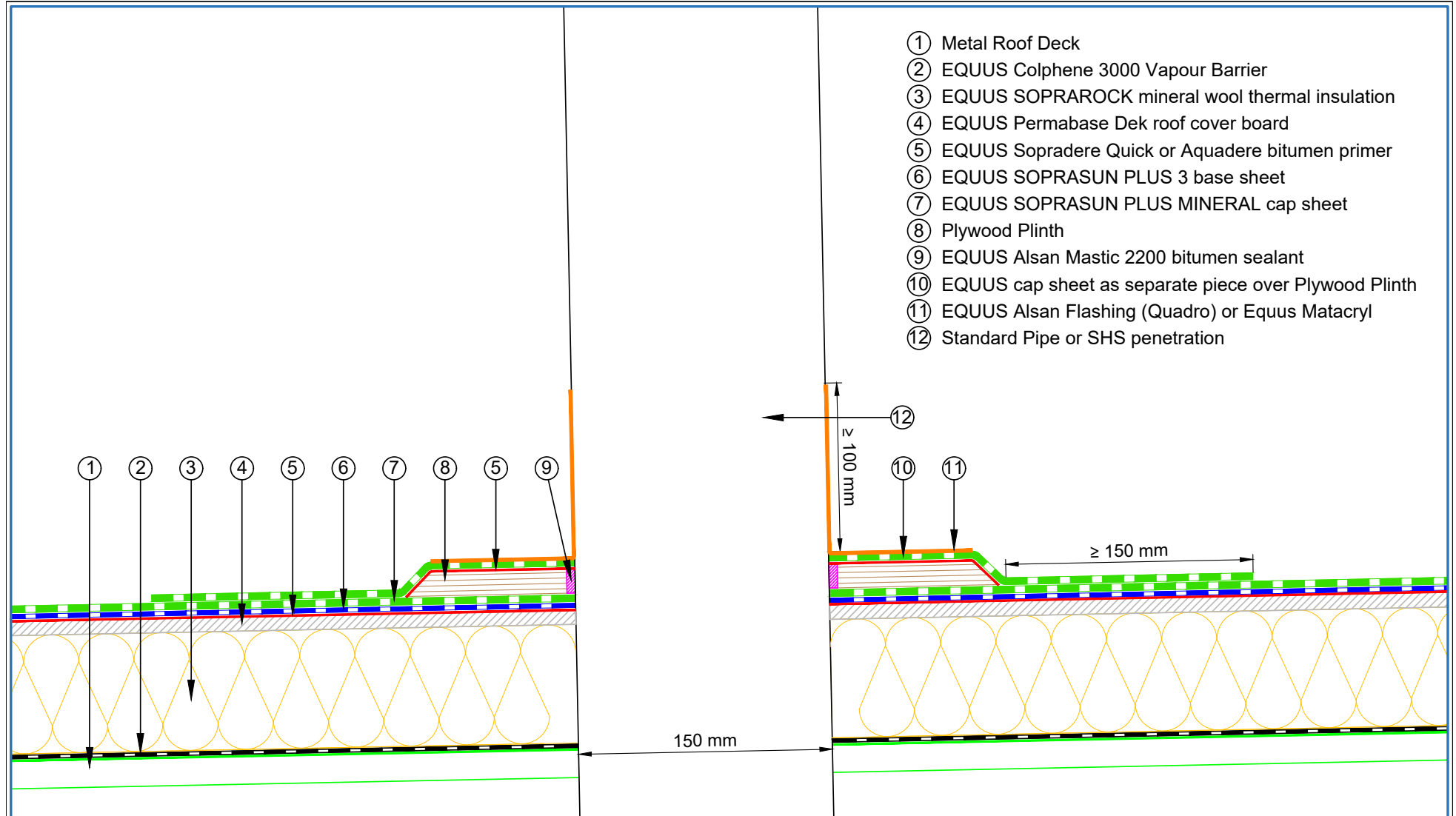

<p>E-mail : admin@equus.co.nz Web : www.equus.co.nz</p>	PROJECT :		Warm Roof on Metal Standard Detail - SOPRASUN		
	TITLE :		Standard Pipe or SHS penetration with cover board (Mineral wool insulation)		
	NUMBER :		SSWRM-D5d	SCALE :	1 : 3
	DRAWN BY :	NKT	DATE :	29-Aug-2022	REVISED :
	<p>Equus Waterproof Membrane Details are specially drawn for use by Local Authorities, Building Contractors, Equus Applicators, Architects and design professionals. All details are drawn to assist in the development of project specific details. Details may be modified where necessary to accommodate job specific requirements but must be approved by Equus Industries Ltd. All components must be supplied by Equus Industries Ltd. Equus reserves the right to alter or upgrade details at any time without prior notice.</p>				



- ① Metal Roof Deck
- ② EQUUS Colphene 3000 Vapour Barrier
- ③ EQUUS PIR thermal insulation
- ④ EQUUS SOPRASUN PLUS 3 base sheet
- ⑤ EQUUS SOPRASUN PLUS MINERAL cap sheet
- ⑥ Plywood Plinth
- ⑦ EQUUS Sopradere Quick or Aquadere bitumen primer
- ⑧ EQUUS Alsan Mastic 2200 bitumen sealant
- ⑨ EQUUS cap sheet as separate piece over Plywood Plinth
- ⑩ EQUUS Alsan Flashing (Quadro) or Equus Matacryl
- ⑪ Electrical Conduit with SBS Flange

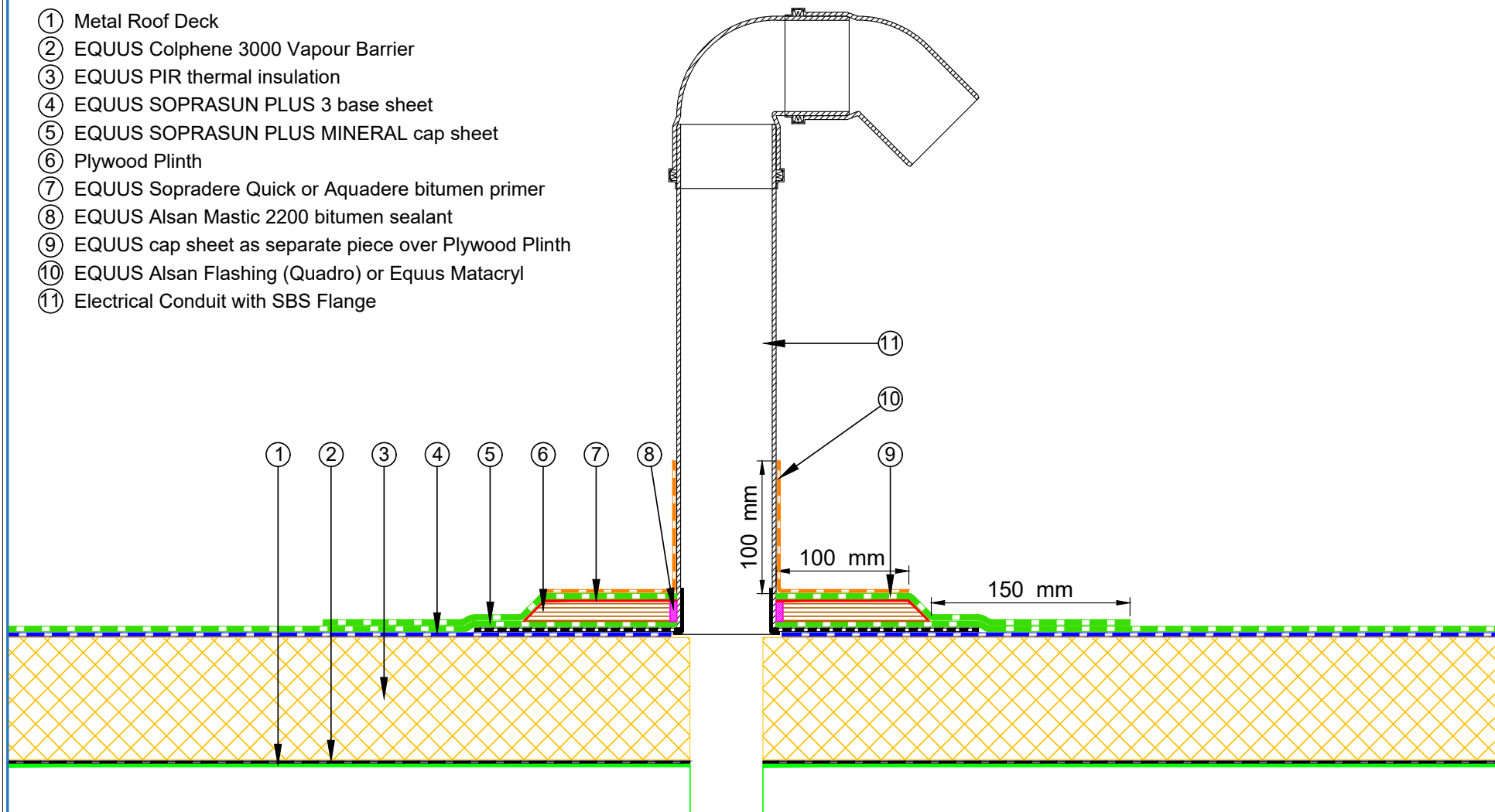

E-mail : admin@equus.co.nz
Web : www.equus.co.nz

PROJECT :	Warm Roof on Metal Standard Detail - SOPRASUN		
TITLE :	Electrical conduit (PIR insulation)		
NUMBER :	SSWRM-D6a	SCALE :	1 : 4
DRAWN BY :	NKT	DATE :	29-Aug-2022
REVISED :			

Equus Waterproof Membrane Details are specially drawn for use by Local Authorities, Building Contractors, Equus Applicators, Architects and design professionals. All details are drawn to assist in the development of project specific details. Details may be modified where necessary to accommodate job specific requirements but must be approved by Equus Industries Ltd. All components must be supplied by Equus Industries Ltd. Equus reserves the right to alter or upgrade details at any time without prior notice.



- ① Metal Roof Deck
- ② EQUUS Colphene 3000 Vapour Barrier
- ③ EQUUS SOPRAROCK mineral wool thermal insulation
- ④ EQUUS SOPRASUN PLUS 3 base sheet
- ⑤ EQUUS SOPRASUN PLUS MINERAL cap sheet
- ⑥ Plywood Plinth
- ⑦ EQUUS Sopradere Quick primer
- ⑧ EQUUS Alsan Mastic 2200 bitumen sealant
- ⑨ EQUUS cap sheet as separate piece over Plywood Plinth
- ⑩ EQUUS Alsan Flashing (Quadro) or Equus Matacryl
- ⑪ Electrical Conduit with SBS Flange

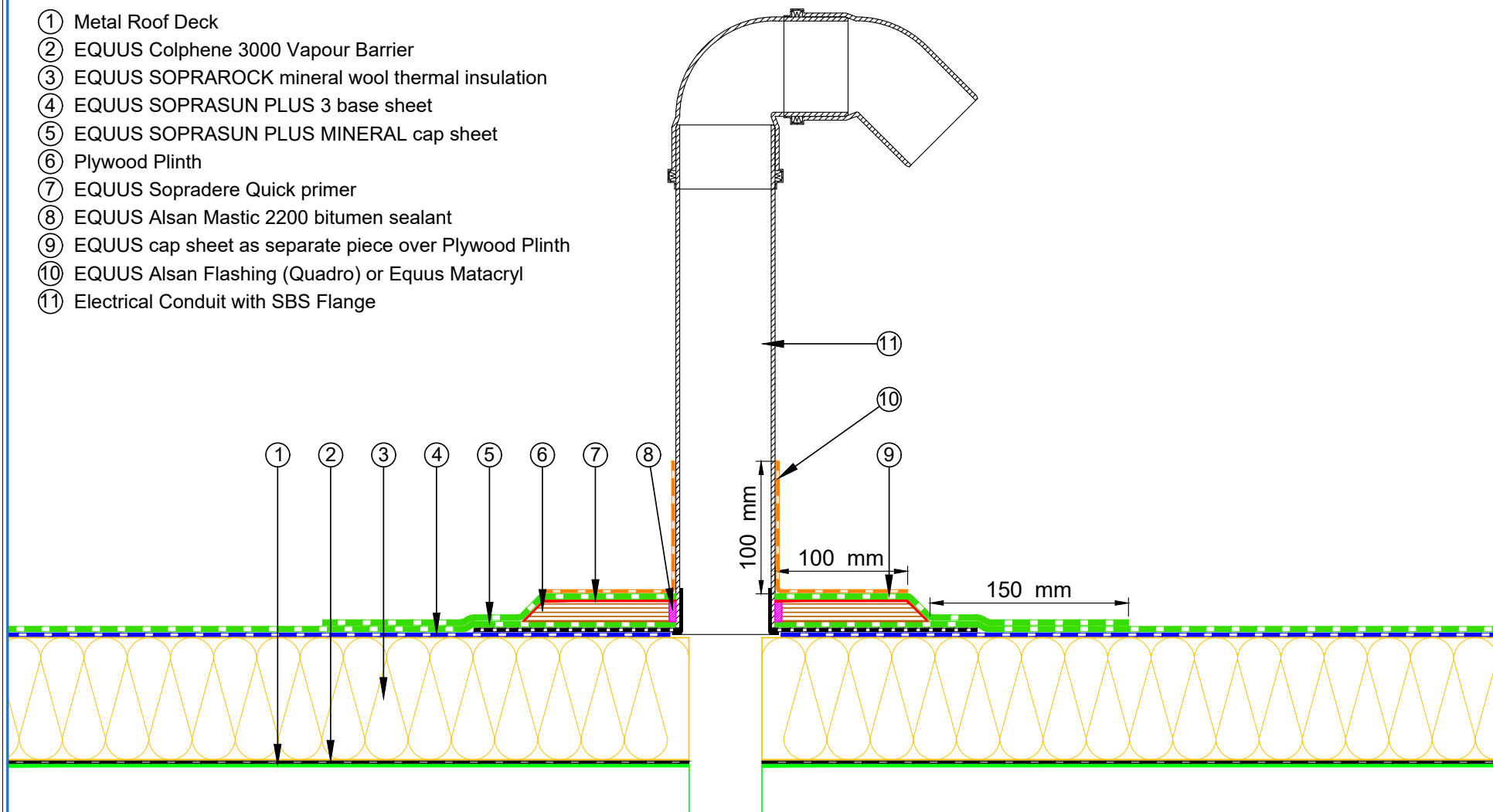

E-mail : admin@equus.co.nz
Web : www.equus.co.nz

PROJECT :	Warm Roof on Metal Standard Detail - SOPRASUN		
TITLE :	Electrical conduit (Mineral wool insulation)		
NUMBER :	SSWRM-D6b	SCALE :	1 : 4
DRAWN BY :	NKT	DATE :	29-Aug-2022
REVISED :			
<p><small>Equus Waterproof Membrane Details are specially drawn for use by Local Authorities, Building Contractors, Equus Applicators, Architects and design professionals. All details are drawn to assist in the development of project specific details. Details may be modified where necessary to accommodate job specific requirements but must be approved by Equus Industries Ltd. All components must be supplied by Equus Industries Ltd. Equus reserves the right to alter or upgrade details at any time without prior notice.</small></p>			



- ① Metal Roof Deck
- ② EQUUS Colphene 3000 Vapour Barrier
- ③ EQUUS Mineral wool insulation
- ④ EQUUS Permabase Dek roof cover board
- ⑤ EQUUS Sopradere Quick or Aquadere bitumen primer
- ⑥ EQUUS SOPRASUN PLUS 3 base sheet
- ⑦ EQUUS SOPRASUN PLUS MINERAL cap sheet
- ⑧ EQUUS DoubleStick Micro Sealant Putty Tape
- ⑨ Flange of Electrical Conduit
- ⑩ EQUUS cap sheet as separate piece over Flange
- ⑪ EQUUS Alsan Flashing (Quadro) or Equus Maticryl
- ⑫ Electrical Conduit with Flange

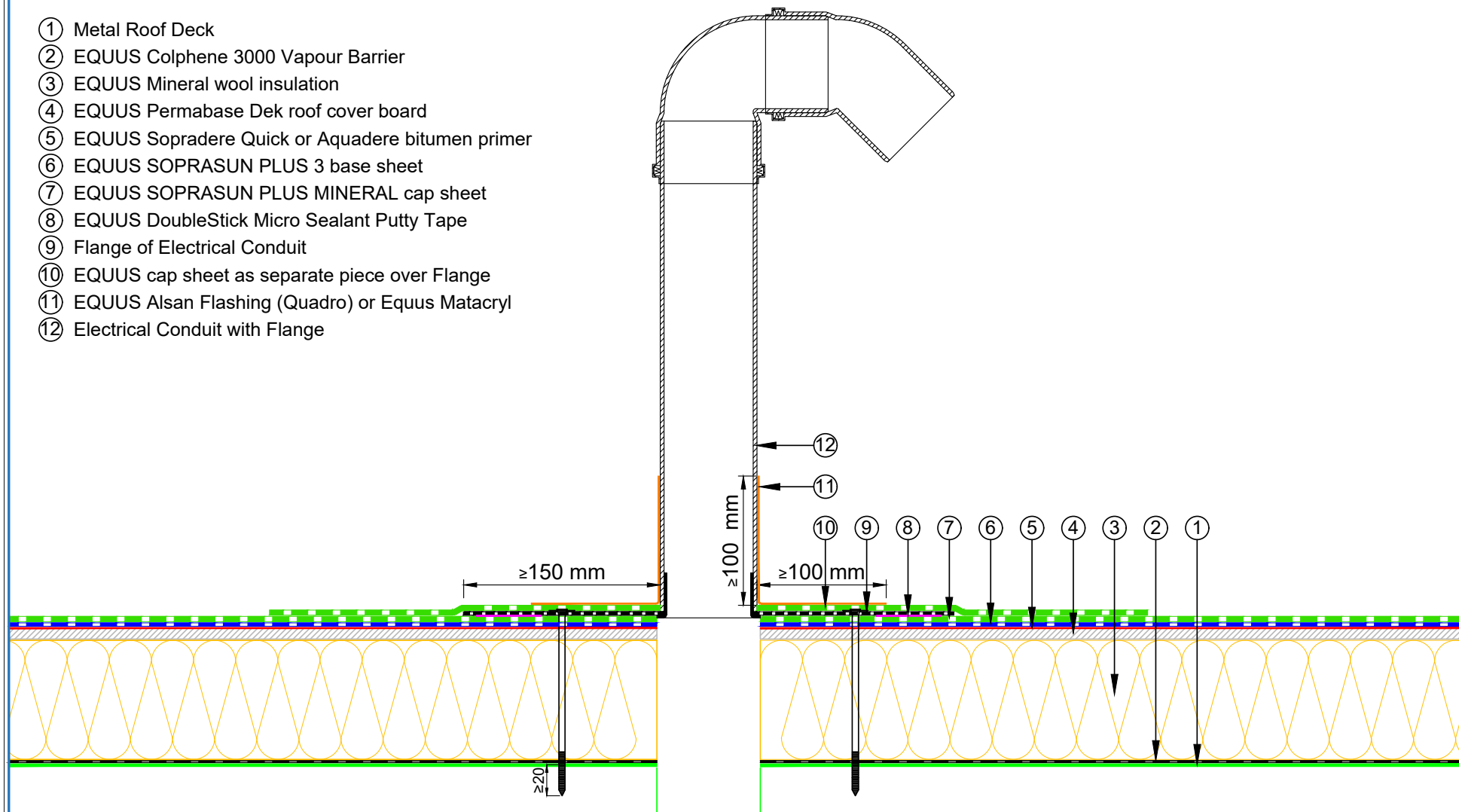

E-mail : admin@equus.co.nz
Web : www.equus.co.nz

PROJECT :	Warm Roof on Metal Standard Detail - SOPRASUN		
TITLE :	Electrical conduit with roof cover board (Mineral wool insulation)		
NUMBER :	SSWRM-D6c	SCALE :	NTS
DRAWN BY :	NKT	DATE :	29-Aug-2022
REVISED :			

Equus Waterproof Membrane Details are specially drawn for use by Local Authorities, Building Contractors, Equus Applicators, Architects and design professionals. All details are drawn to assist in the development of project specific details. Details may be modified where necessary to accommodate job specific requirements but must be approved by Equus Industries Ltd. All components must be supplied by Equus Industries Ltd. Equus reserves the right to alter or upgrade details at any time without prior notice.



- ① Metal Roof Deck
- ② EQUUS Colphene 3000 Vapour Barrier
- ③ EQUUS PIR thermal insulation
- ④ EQUUS SOPRASUN PLUS 3 base sheet
- ⑤ EQUUS SOPRASUN PLUS MINERAL cap sheet
- ⑥ EQUUS Permabase Dek roof cover board
- ⑦ Timber Roof Batten
- ⑧ EQUUS Sopradere Quick primer
- ⑨ EQUUS cap sheet as separate piece over Plywood Plinth
- ⑩ EPDM Washer under Screwhead
- ⑪ Roof Equipment

STEP 1: Fixing of the batten

STEP 2: Fixing of the Equipment

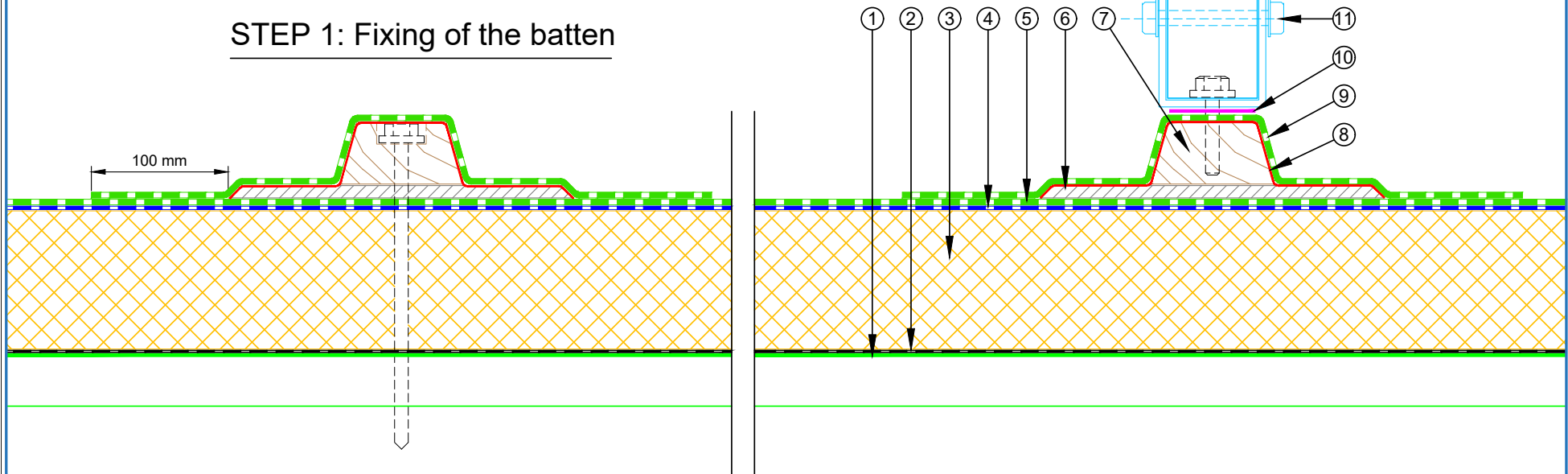

PROJECT :	Warm Roof on Metal Standard Detail - SOPRASUN		
TITLE :	Roof Equipment Support Batten (PIR insulation)		
NUMBER :	SSWRM-D7a	SCALE :	1 : 4
DRAWN BY :	NKT	DATE :	29-Aug-2022
REVISED :			
<p><small>Equus Waterproof Membrane Details are specially drawn for use by Local Authorities, Building Contractors, Equus Applicators, Architects and design professionals. All details are drawn to assist in the development of project specific details. Details may be modified where necessary to accommodate job specific requirements but must be approved by Equus Industries Ltd. All components must be supplied by Equus Industries Ltd. Equus reserves the right to alter or upgrade details at any time without prior notice.</small></p>			

- ① Metal Roof Deck
- ② EQUUS Colphene 3000 Vapour Barrier
- ③ EQUUS SOPRAROCK mineral wool thermal insulation
- ④ EQUUS SOPRASUN PLUS 3 base sheet
- ⑤ EQUUS SOPRASUN PLUS MINERAL cap sheet
- ⑥ EQUUS Permabase Dek roof cover board
- ⑦ Timber Roof Batten
- ⑧ EQUUS Sopradere Quick primer
- ⑨ EQUUS cap sheet as separate piece over Plywood Plinth
- ⑩ EPDM Washer under Screwhead
- ⑪ Roof Equipment

STEP 2: Fixing of the Equipment

STEP 1: Fixing of the batten

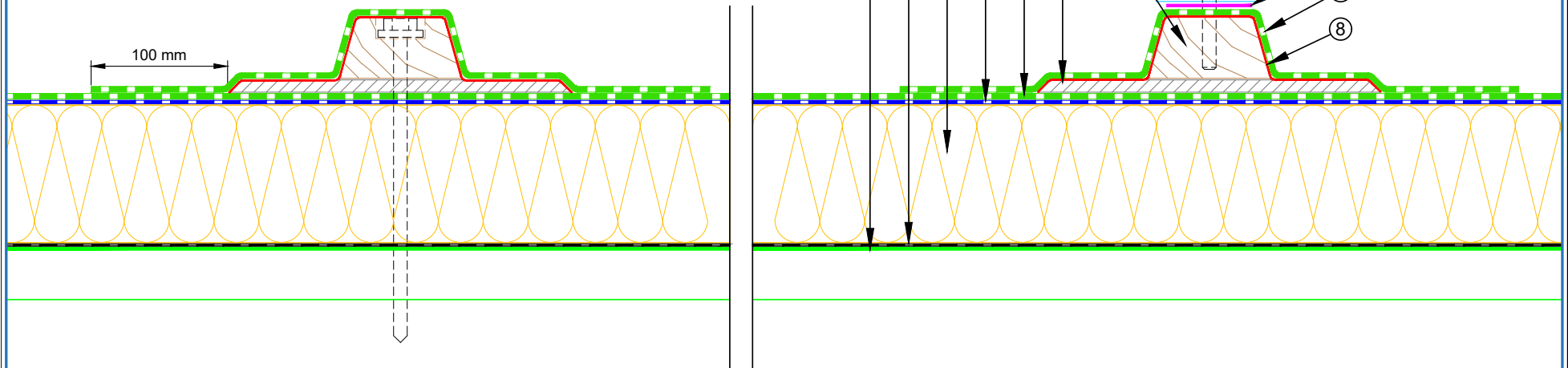

E-mail : admin@equus.co.nz
Web : www.equus.co.nz

PROJECT :	Standard Detail		
TITLE :	Roof Equipment Support Batten (Mineral wool insulation)		
NUMBER :	SSWRM-D7b	SCALE :	1 : 4
DRAWN BY :	NKT	DATE :	29-Aug-2022
		REVISED :	
<p><small>Equus Waterproof Membrane Details are specially drawn for use by Local Authorities, Building Contractors, Equus Applicators, Architects and design professionals. All details are drawn to assist in the development of project specific details. Details may be modified where necessary to accommodate job specific requirements but must be approved by Equus Industries Ltd. All components must be supplied by Equus Industries Ltd. Equus reserves the right to alter or upgrade details at any time without prior notice.</small></p>			



- ① Metal Roof Deck
- ② EQUUS Colphene 3000 Vapour Barrier
- ③ EQUUS PIR thermal insulation
- ④ EQUUS SOPRASUN PLUS 3 base sheet
- ⑤ EQUUS SOPRASUN PLUS MINERAL cap sheet
- ⑥ EQUUS cap sheet as separate piece over Plywood Plinth
- ⑦ EQUUS Permabase Dek roof cover board
- ⑧ EQUUS Sopradere Quick primer
- ⑨ EQUUS bitumen fillet or approved alternative
- ⑩ EPDM Washer under Screwhead
- ⑪ Timber Roof Batten
- ⑫ Roof Equipment

STEP 1: Fixing of the batten

STEP 2: Fixing of the Equipment

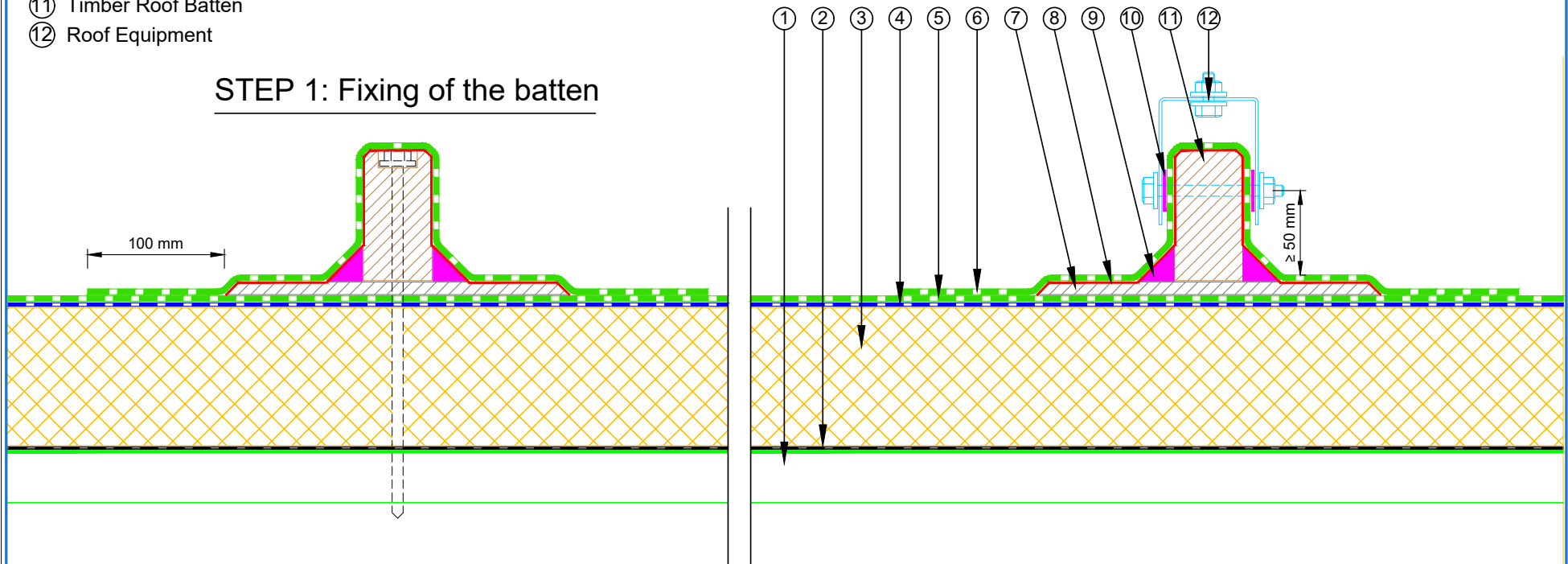

PROJECT :	Warm Roof on Metal Standard Detail - SOPRASUN		
TITLE :	Roof Equipment Support Batten - optional (PIR insulation)		
NUMBER :	SSWRM-D7c	SCALE :	1 : 4
DRAWN BY :	NKT	DATE :	29-Aug-2022
REVIS		REVISED :	
<p><small>Equus Waterproof Membrane Details are specially drawn for use by Local Authorities, Building Contractors, Equus Applicators, Architects and design professionals. All details are drawn to assist in the development of project specific details. Details may be modified where necessary to accommodate job specific requirements but must be approved by Equus Industries Ltd. All components must be supplied by Equus Industries Ltd. Equus reserves the right to alter or upgrade details at any time without prior notice.</small></p>			

- ① Metal Roof Deck
- ② EQUUS Colphene 3000 Vapour Barrier
- ③ EQUUS SOPRAROCK mineral wool thermal insulation
- ④ EQUUS SOPRASUN PLUS 3 base sheet
- ⑤ EQUUS SOPRASUN PLUS MINERAL cap sheet
- ⑥ EQUUS cap sheet as separate piece over Plywood Plinth
- ⑦ EQUUS Permabase Dek roof cover board
- ⑧ EQUUS Sopradere Quick primer
- ⑨ EQUUS bitumen fillet or approved alternative
- ⑩ EPDM Washer under Screwhead
- ⑪ Timber Roof Batten
- ⑫ Roof Equipment

STEP 1: Fixing of the batten

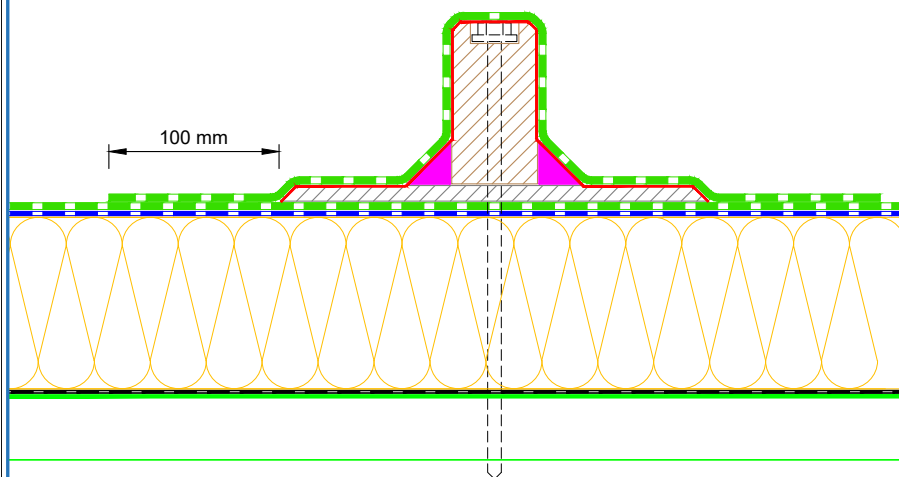

STEP 2: Fixing of the Equipment

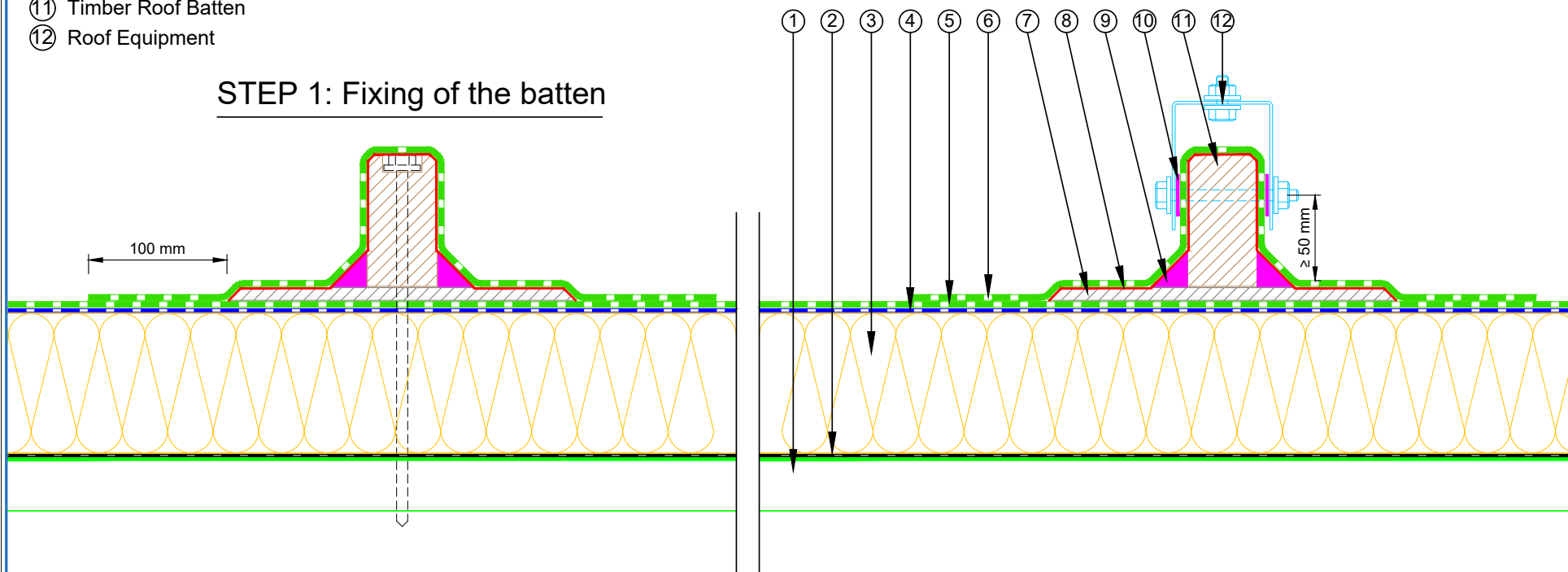

E-mail : admin@equus.co.nz
Web : www.equus.co.nz

PROJECT :	Warm Roof on Metal Standard Detail - SOPRASUN		
TITLE :	Roof Equipment Support Batten - optional (Mineral wool insulation)		
NUMBER :	SSWRM-D7d	SCALE :	1 : 4
DRAWN BY :	NKT	DATE :	29-Aug-2022
REVISED :			

Equus Waterproof Membrane Details are specially drawn for use by Local Authorities, Building Contractors, Equus Applicators, Architects and design professionals. All details are drawn to assist in the development of project specific details. Details may be modified where necessary to accommodate job specific requirements but must be approved by Equus Industries Ltd. All components must be supplied by Equus Industries Ltd. Equus reserves the right to alter or upgrade details at any time without prior notice.



- ① Metal Roof Deck
- ② EQUUS Colphene 3000 Vapour Barrier
- ③ EQUUS PIR thermal insulation
- ④ EQUUS SOPRASUN PLUS 3 base sheet
- ⑤ EQUUS SOPRASUN PLUS MINERAL cap sheet
- ⑥ EQUUS cap sheet as separate piece over Plywood Plinth
- ⑦ Plywood Plinth
- ⑧ EQUUS Sopradere Quick primer
- ⑨ EQUUS bitumen fillet or approved alternative
- ⑩ Skylight Joinery

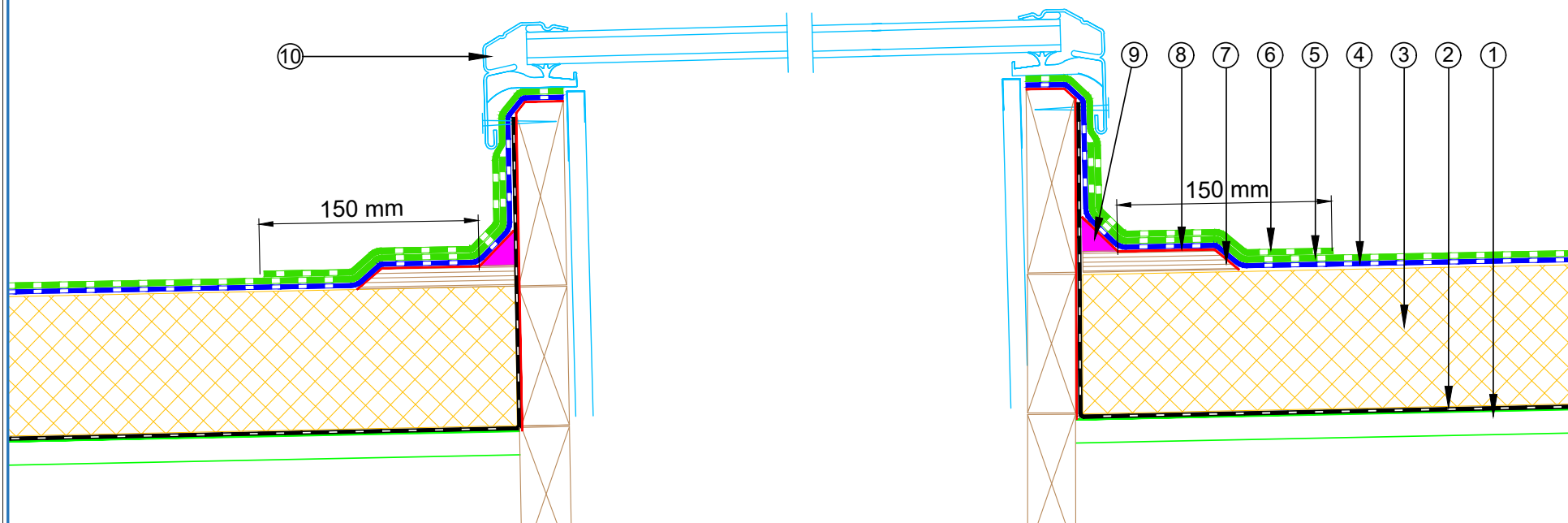

<p>E-mail : admin@equus.co.nz Web : www.equus.co.nz</p>	PROJECT :	Warm Roof on Metal Standard Detail - SOPRASUN		
	TITLE :	Skylight (PIR insulation)		
	NUMBER :	SSWRM-D8a	SCALE :	1 : 4
	DRAWN BY :	NKT	DATE :	29-Aug-2022
			REVISED :	
<p>Equus Waterproof Membrane Details are specially drawn for use by Local Authorities, Building Contractors, Equus Applicators, Architects and design professionals. All details are drawn to assist in the development of project specific details. Details may be modified where necessary to accommodate job specific requirements but must be approved by Equus Industries Ltd. All components must be supplied by Equus Industries Ltd. Equus reserves the right to alter or upgrade details at any time without prior notice.</p>				
		<p>AUTHORISED DISTRIBUTOR SOPREMA</p>		

- ① Metal Roof Deck
- ② EQUUS Colphene 3000 Vapour Barrier
- ③ EQUUS SOPRAROCK mineral wool thermal insulation
- ④ EQUUS SOPRASUN PLUS 3 base sheet
- ⑤ EQUUS SOPRASUN PLUS MINERAL cap sheet
- ⑥ EQUUS cap sheet as separate piece over Plywood Plinth
- ⑦ Plywood Plinth
- ⑧ EQUUS Sopradere Quick primer
- ⑨ EQUUS bitumen fillet or approved alternative
- ⑩ Skylight Joinery

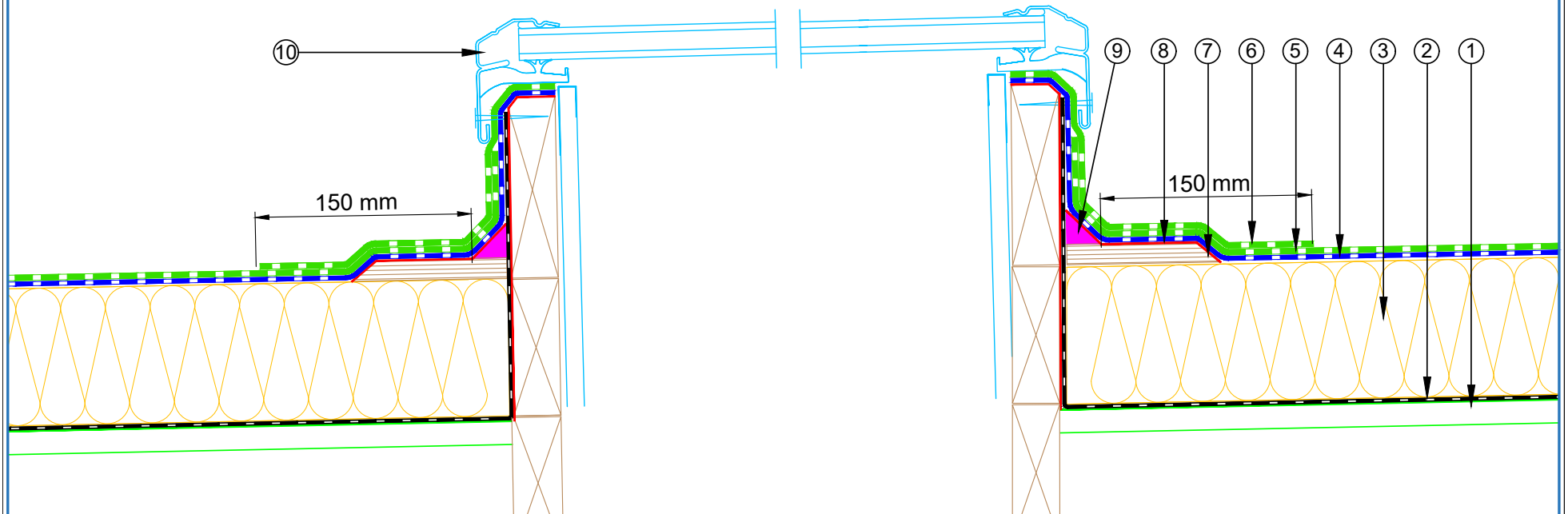

<p>E-mail : admin@equus.co.nz Web : www.equus.co.nz</p>	PROJECT :	Warm Roof on Metal Standard Detail - SOPRASUN		
	TITLE :	Skylight (Mineral wool insulation)		
	NUMBER :	SSWRM-D8b	SCALE :	1 : 4
	DRAWN BY :	NKT	DATE :	29-Aug-2022
			REVISED :	
<p>Equus Waterproof Membrane Details are specially drawn for use by Local Authorities, Building Contractors, Equus Applicators, Architects and design professionals. All details are drawn to assist in the development of project specific details. Details may be modified where necessary to accommodate job specific requirements but must be approved by Equus Industries Ltd. All components must be supplied by Equus Industries Ltd. Equus reserves the right to alter or upgrade details at any time without prior notice.</p>				
		<p>AUTHORISED DISTRIBUTOR SOPREMA</p>		

- ① Metal Roof Deck
- ② EQUUS Colphene 3000 Vapour Barrier
- ③ EQUUS PIR thermal insulation
- ④ EQUUS SOPRASUN PLUS 3 base sheet
- ⑤ EQUUS SOPRASUN PLUS MINERAL cap sheet
- ⑥ Plywood Plinth
- ⑦ EQUUS Sopradere Quick primer
- ⑧ Toggle Fixing
- ⑨ EQUUS cap sheet as separate piece over Plywood Plinth
- ⑩ Fall Restraint Anchor
- ⑪ EQUUS Alsan Mastic 2200 bitumen sealant

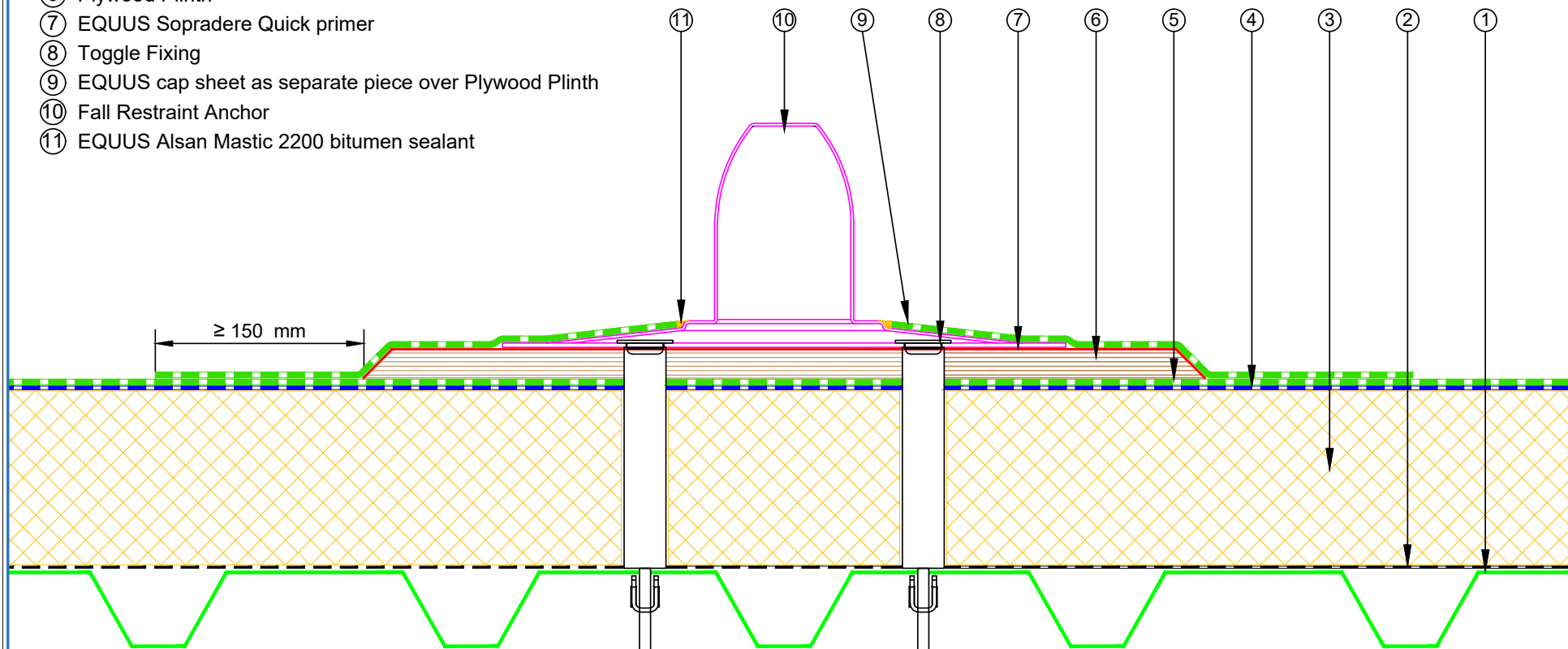

 E-mail : admin@equus.co.nz Web : www.equus.co.nz	PROJECT :		Warm Roof on Metal Standard Detail - SOPRASUN		 AUTHORISED DISTRIBUTOR SOPREMA
	TITLE :		Fall restraint (PIR insulation)		
	NUMBER :	SSWRM-D9a	SCALE :	1 : 4	
	DRAWN BY :	NKT	DATE :	29-Aug-2022	
	REVISD :				
<p><small>Equus Waterproof Membrane Details are specially drawn for use by Local Authorities, Building Contractors, Equus Applicators, Architects and design professionals. All details are drawn to assist in the development of project specific details. Details may be modified where necessary to accommodate job specific requirements but must be approved by Equus Industries Ltd. All components must be supplied by Equus Industries Ltd. Equus reserves the right to alter or upgrade details at any time without prior notice.</small></p>					

- ① Metal Roof Deck
- ② EQUUS Colphene 3000 Vapour Barrier
- ③ EQUUS SOPRAROCK mineral wool thermal insulation
- ④ EQUUS SOPRASUN PLUS 3 base sheet
- ⑤ EQUUS SOPRASUN PLUS MINERAL cap sheet
- ⑥ Plywood Plinth
- ⑦ EQUUS Sopradere Quick primer
- ⑧ Toggle Fixing
- ⑨ EQUUS cap sheet as separate piece over Plywood Plinth
- ⑩ Fall Restraint Anchor
- ⑪ EQUUS Alsan Mastic 2200 bitumen sealant

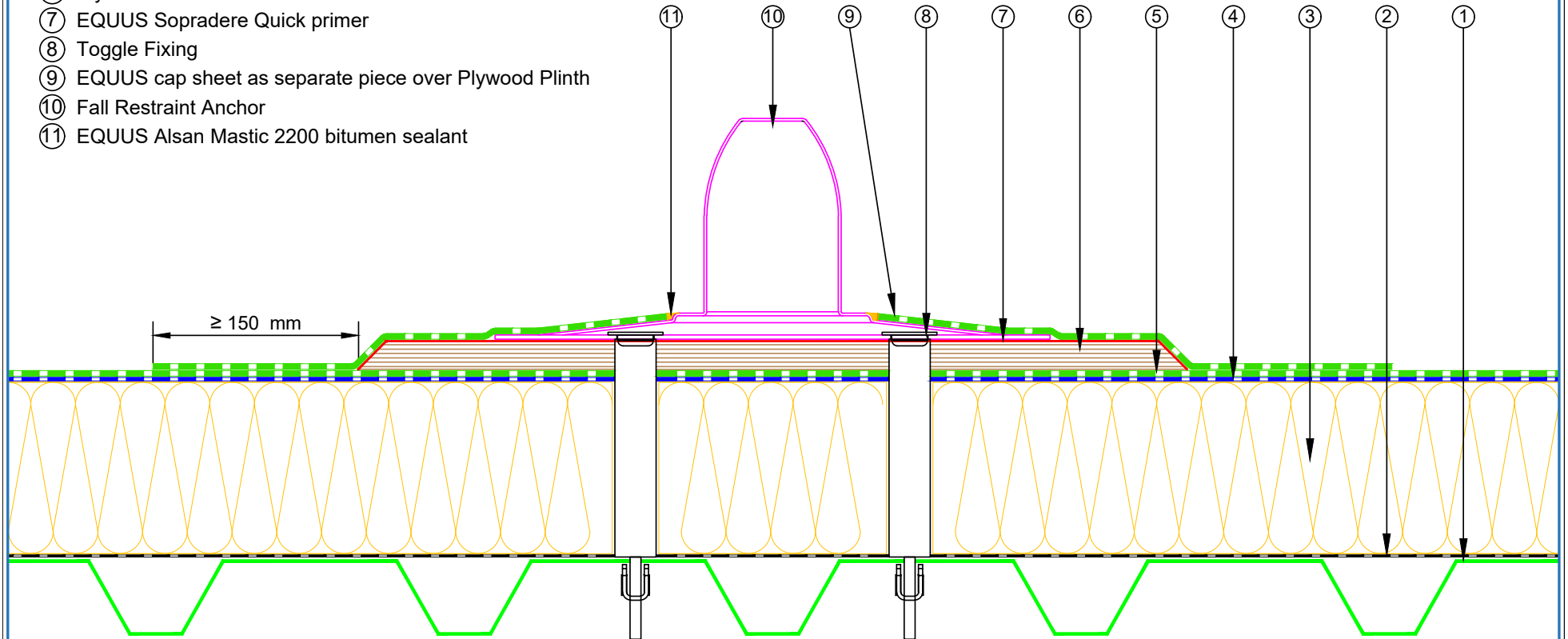

E-mail : admin@equus.co.nz
Web : www.equus.co.nz

PROJECT :	Warm Roof on Metal Standard Detail - SOPRASUN		
TITLE :	Fall restraint (Mineral wool insulation)		
NUMBER :	SSWRM-D9b	SCALE :	1 : 4
DRAWN BY :	NKT	DATE :	29-Aug-2022
REVISED :			
<p><small>Equus Waterproof Membrane Details are specially drawn for use by Local Authorities, Building Contractors, Equus Applicators, Architects and design professionals. All details are drawn to assist in the development of project specific details. Details may be modified where necessary to accommodate job specific requirements but must be approved by Equus Industries Ltd. All components must be supplied by Equus Industries Ltd. Equus reserves the right to alter or upgrade details at any time without prior notice.</small></p>			

AUTHORISED DISTRIBUTOR
SOPREMA

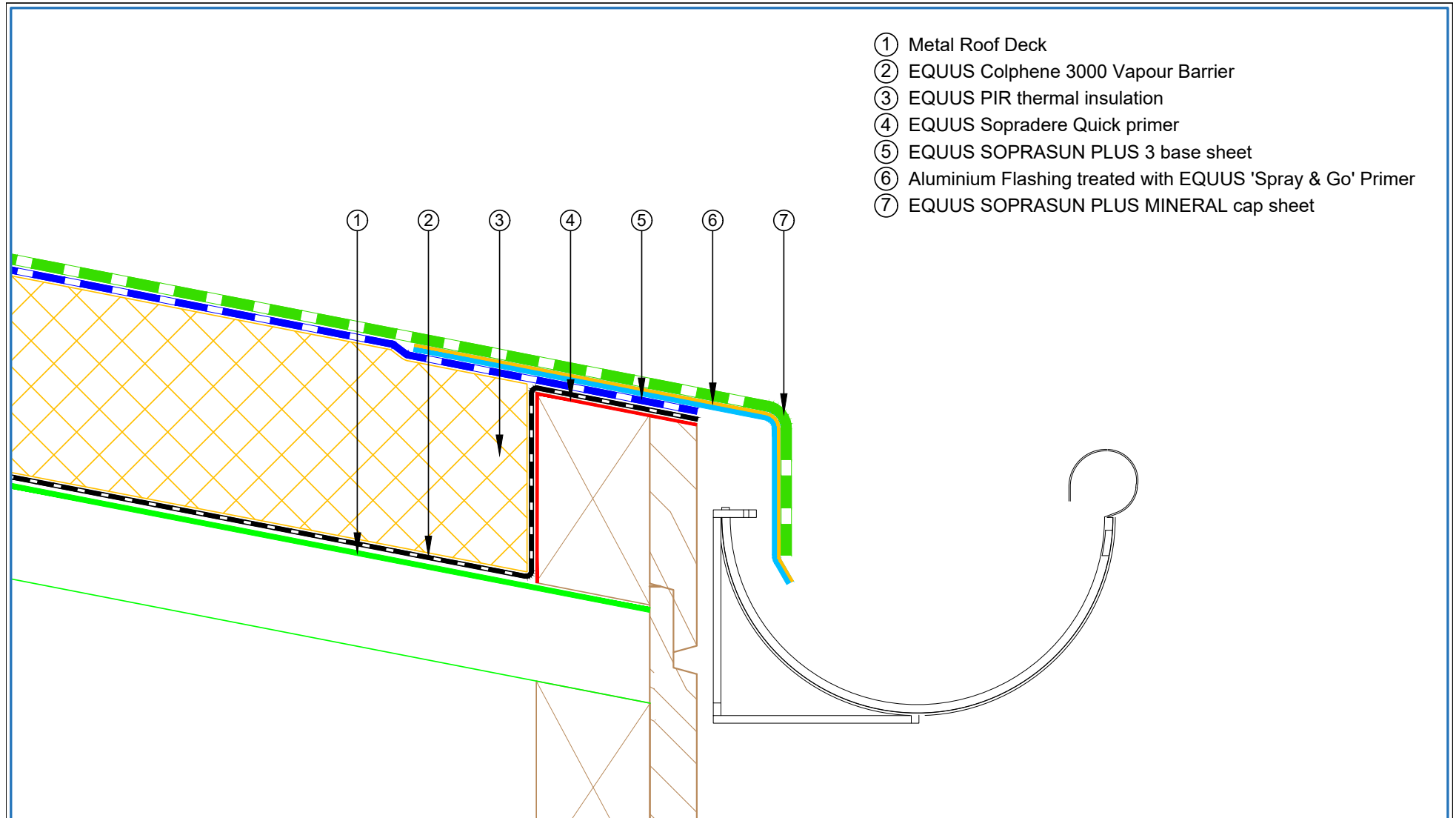

- ① Metal Roof Deck
- ② EQUUS Colphene 3000 Vapour Barrier
- ③ EQUUS PIR thermal insulation
- ④ EQUUS Sopradere Quick primer
- ⑤ EQUUS SOPRASUN PLUS 3 base sheet
- ⑥ Aluminium Flashing treated with EQUUS 'Spray & Go' Primer
- ⑦ EQUUS SOPRASUN PLUS MINERAL cap sheet

 E-mail : admin@equus.co.nz Web : www.equus.co.nz	PROJECT :		Warm Roof on Metal Standard Detail - SOPRASUN		 AUTHORISED DISTRIBUTOR SOPREMA
	TITLE :		Connection to External Gutter (PIR insulation)		
	NUMBER :	SSWRM-D10a	SCALE :	1 : 2	
	DRAWN BY :	NKT	DATE :	27-Aug-2022	
	REVISD :				
<p><small>Equus Waterproof Membrane Details are specially drawn for use by Local Authorities, Building Contractors, Equus Applicators, Architects and design professionals. All details are drawn to assist in the development of project specific details. Details may be modified where necessary to accommodate job specific requirements but must be approved by Equus Industries Ltd. All components must be supplied by Equus Industries Ltd. Equus reserves the right to alter or upgrade details at any time without prior notice.</small></p>					

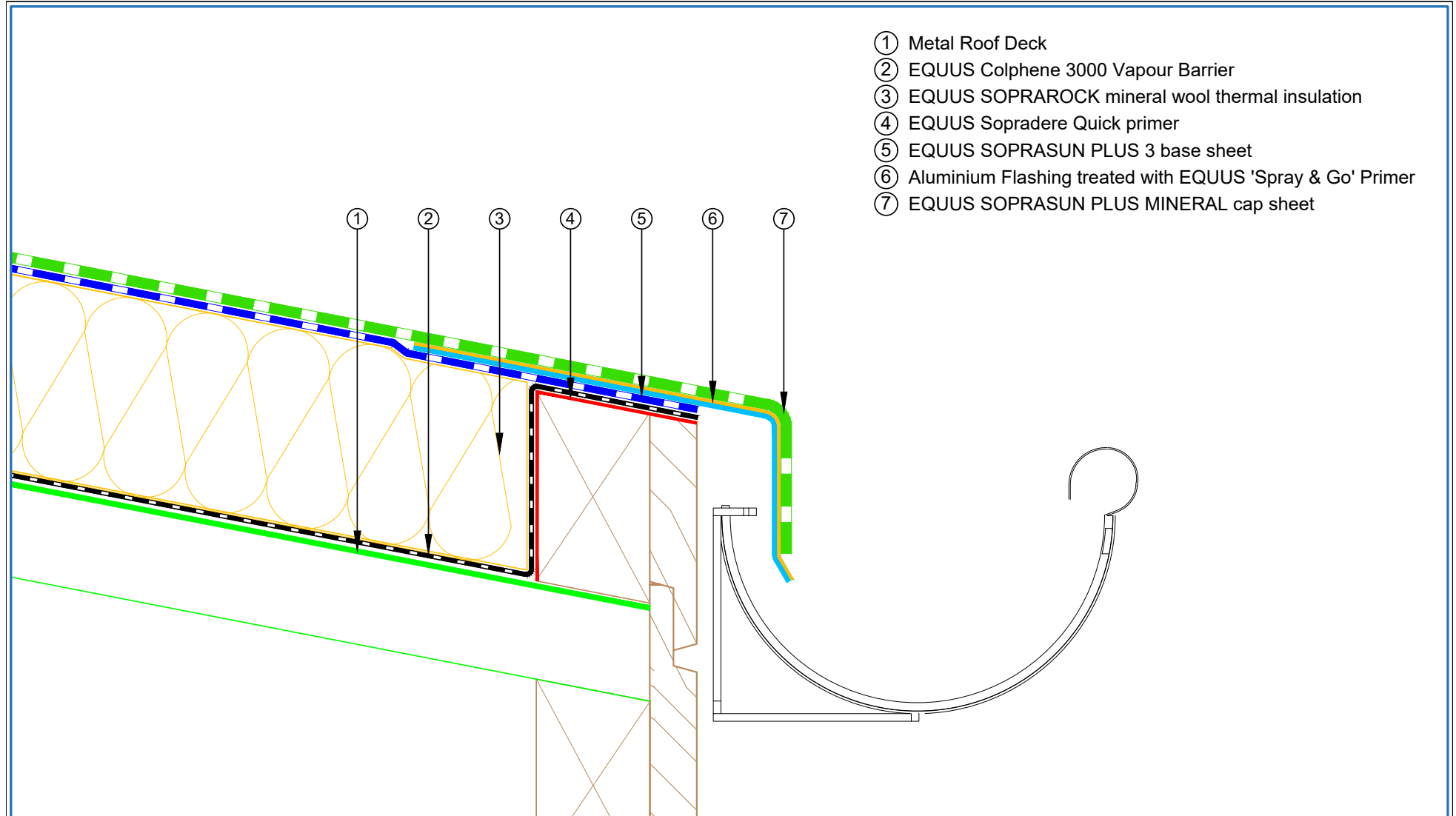

- ① Metal Roof Deck
- ② EQUUS Colphene 3000 Vapour Barrier
- ③ EQUUS SOPRAROCK mineral wool thermal insulation
- ④ EQUUS Sopradere Quick primer
- ⑤ EQUUS SOPRASUN PLUS 3 base sheet
- ⑥ Aluminium Flashing treated with EQUUS 'Spray & Go' Primer
- ⑦ EQUUS SOPRASUN PLUS MINERAL cap sheet

 E-mail : admin@equus.co.nz Web : www.equus.co.nz	PROJECT :		Warm Roof on Metal Standard Detail - SOPRASUN		 AUTHORISED DISTRIBUTOR SOPREMA	
	TITLE :		Connection to External Gutter (Mineral wool insulation)			
	NUMBER :		SSWRM-D10b	SCALE :		1 : 2
	DRAWN BY :		NKT	DATE :		27-Aug-2022
				REVISED :		
<p><small>Equus Waterproof Membrane Details are specially drawn for use by Local Authorities, Building Contractors, Equus Applicators, Architects and design professionals. All details are drawn to assist in the development of project specific details. Details may be modified where necessary to accommodate job specific requirements but must be approved by Equus Industries Ltd. All components must be supplied by Equus Industries Ltd. Equus reserves the right to alter or upgrade details at any time without prior notice.</small></p>						