



EQUUS CHEVALINE EPISTIXX CP CARPARK SYSTEM

Standard Details



CELEBRATING
40 YEARS
1982-2022

JULY 2024

CONTENTS

ECECP-D1	Carpark Floor Coating Build Up (3D)	1
ECECP-D2	Standard Floor Drain	2
ECECP-D3	Standard Concrete Plinth	3
ECECP-D4	Standard Concrete Nib	4
ECECP-D5	Standard Channel Drain	5
ECECP-D6	Standard Cool Store Panel Wall	6
ECECP-D7	Standard Fixing Detail	7
ECECP-D8	Standard Penetration	8
ECECP-D9	Standard Fixing on Plinth	9

- ① EQUUS Chevaline Epistixx primer
- ② EQUUS Chevaline Epistixx CP
- ③ EQUUS Chevaline Epistixx CP

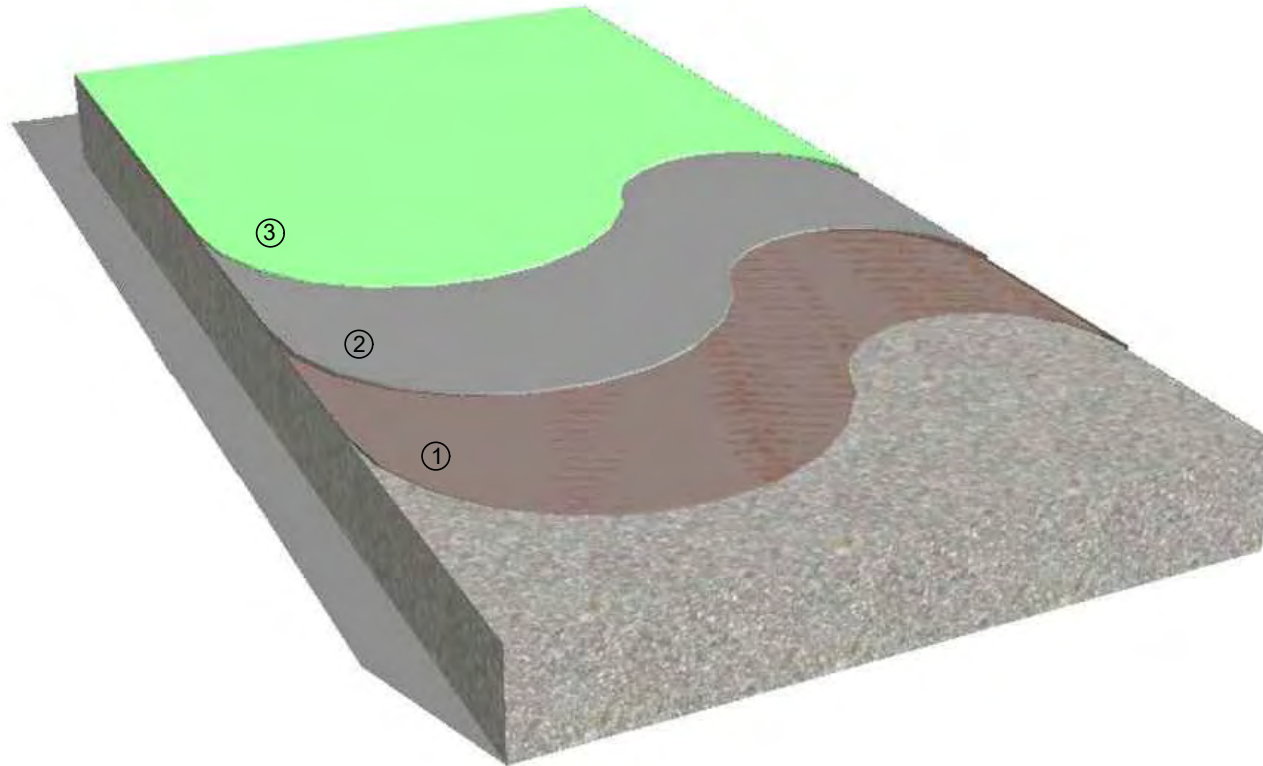

PRODUCT :	Chevaline Epistixx CP Flooring on Interior Concrete Carparks		
TITLE :	Chevaline Epistixx CP carpark floor coating build up (3D)		
NUMBER :	ECECP-D1	SCALE :	NTS
DRAWN BY :	NKT	DATE :	14-June-2023
Equus standard details are especially drawn for use by Local Authorities, Building Contractors, Equus Applicators, Architects and design professionals. All details are drawn to assist in the development of project-specific details. Details may be modified where necessary to accommodate job-specific requirements but must be approved by Equus Industries Ltd. All components must be supplied by Equus Industries Ltd. Equus reserves the right to alter or upgrade details at any time without prior notice.			

- ① EQUUS Chevaline Epistixx primer
- ② EQUUS Chevaline Epistixx CP
- ③ EQUUS Chevaline Epistixx CP

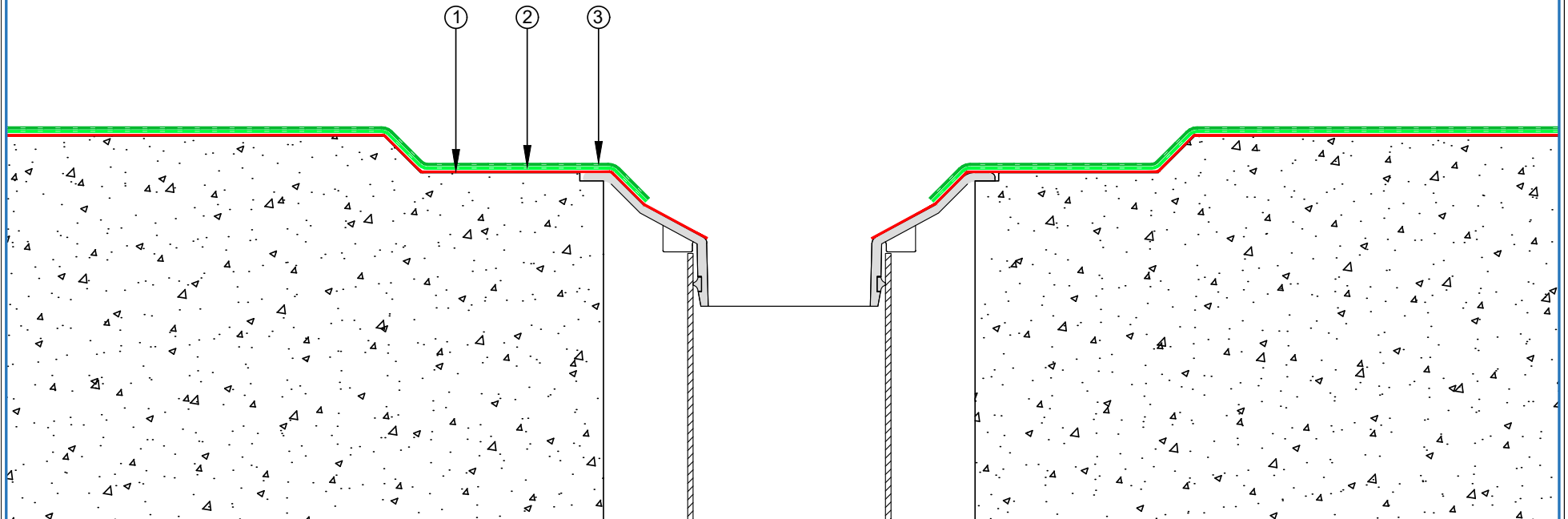

 E-mail : info@equus.nz Web : www.equus.nz	PRODUCT :	Chevaline Epistixx CP Flooring on Interior Concrete Carparks		
	TITLE :	Standard floor drain detail		
	NUMBER :	ECECP-D2	SCALE :	NTS
	DRAWN BY :	NKT	DATE :	14-June-2023
	Revised :			
Equus standard details are especially drawn for use by Local Authorities, Building Contractors, Equus Applicators, Architects and design professionals. All details are drawn to assist in the development of project-specific details. Details may be modified where necessary to accommodate job-specific requirements but must be approved by Equus Industries Ltd. All components must be supplied by Equus Industries Ltd. Equus reserves the right to alter or upgrade details at any time without prior notice.				

- ① EQUUS Chevaline Epistixx primer
- ② EQUUS Chevaline Epistixx CP
- ③ EQUUS Chevaline Epistixx CP
- ④ Mortar fillet

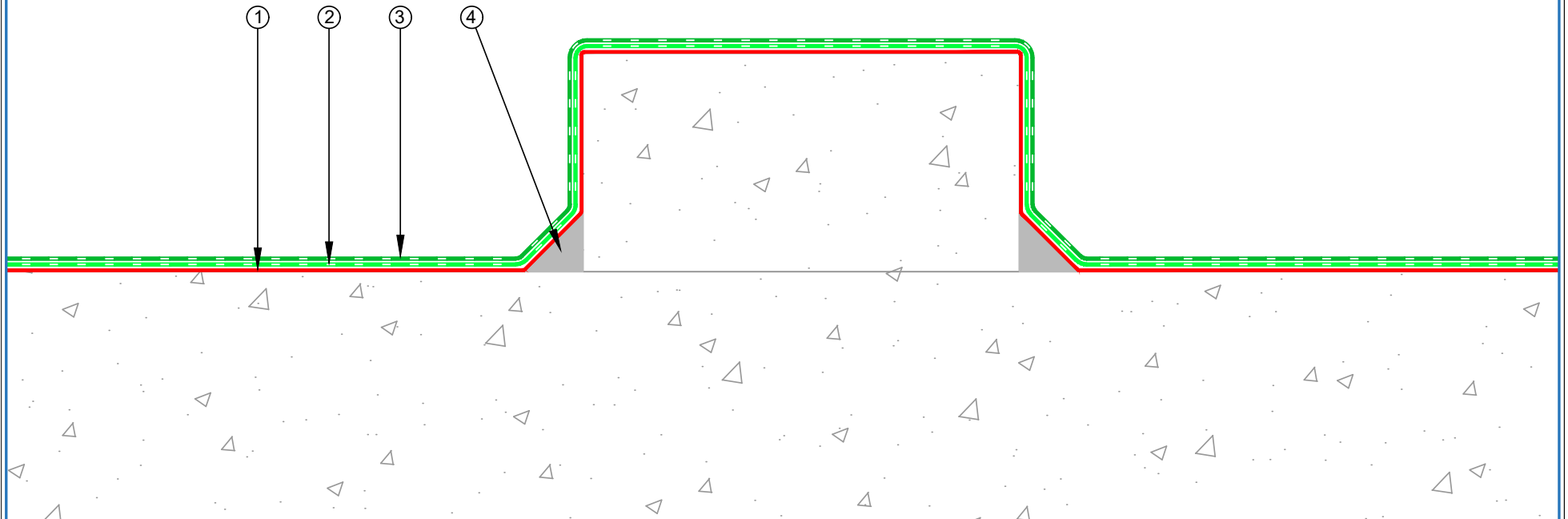

 E-mail : info@equus.nz Web : www.equus.nz	PRODUCT :	Chevaline Epistixx CP Flooring on Interior Concrete Carparks		
	TITLE :	Standard concrete plinth detail		
	NUMBER :	ECECP-D3	SCALE :	NTS
	DRAWN BY :	NKT	DATE :	14-June-2023
	Revised :			
Equus standard details are especially drawn for use by Local Authorities, Building Contractors, Equus Applicators, Architects and design professionals. All details are drawn to assist in the development of project-specific details. Details may be modified where necessary to accommodate job-specific requirements but must be approved by Equus Industries Ltd. All components must be supplied by Equus Industries Ltd. Equus reserves the right to alter or upgrade details at any time without prior notice.				

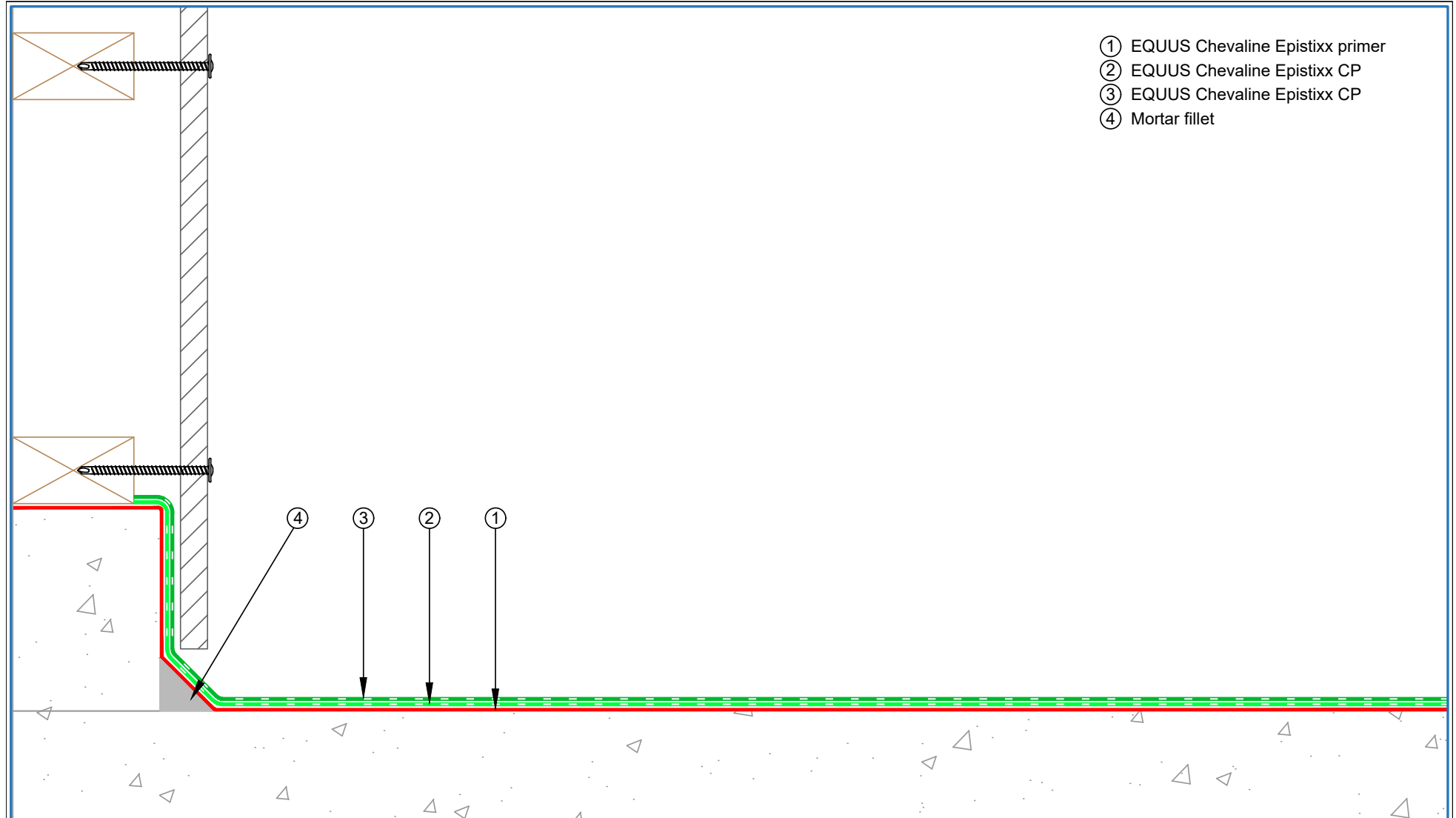

- ① EQUUS Chevaline Epistixx primer
- ② EQUUS Chevaline Epistixx CP
- ③ EQUUS Chevaline Epistixx CP
- ④ Mortar fillet

 E-mail : info@equus.nz Web : www.equus.nz	PRODUCT :	Chevaline Epistixx CP Flooring on Interior Concrete Carparks		
	TITLE :	Standard concrete nib detail		
	NUMBER :	ECECP-D4	SCALE :	NTS
	DRAWN BY :	NKT	DATE :	14-June-2023
			REVISED :	
Equus standard details are especially drawn for use by Local Authorities, Building Contractors, Equus Applicators, Architects and design professionals. All details are drawn to assist in the development of project-specific details. Details may be modified where necessary to accommodate job-specific requirements but must be approved by Equus Industries Ltd. All components must be supplied by Equus Industries Ltd. Equus reserves the right to alter or upgrade details at any time without prior notice.				

- ① EQUUS Chevaline Epistixx primer
- ② EQUUS Chevaline Epistixx CP
- ③ EQUUS Chevaline Epistixx CP
- ④ Mortar fillet

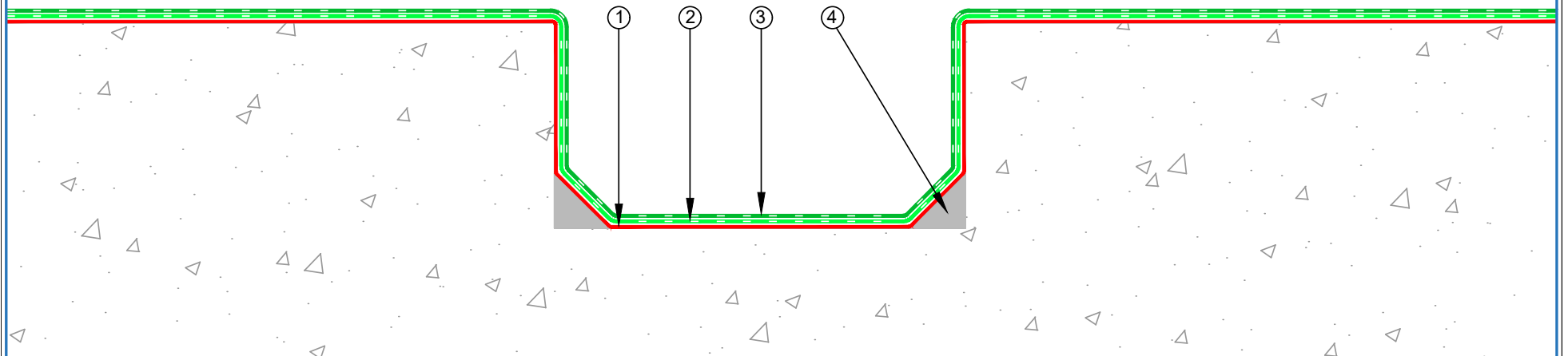

 E-mail : info@equus.nz Web : www.equus.nz	PRODUCT :	Chevaline Epistixx CP Flooring on Interior Concrete Carparks		
	TITLE :	Standard channel drain detail		
	NUMBER :	ECECP-D5	SCALE :	NTS
	DRAWN BY :	NKT	DATE :	14-June-2023
	Revised :			
Equus standard details are especially drawn for use by Local Authorities, Building Contractors, Equus Applicators, Architects and design professionals. All details are drawn to assist in the development of project-specific details. Details may be modified where necessary to accommodate job-specific requirements but must be approved by Equus Industries Ltd. All components must be supplied by Equus Industries Ltd. Equus reserves the right to alter or upgrade details at any time without prior notice.				

- ① EQUUS Chevaline Epistixx primer
- ② EQUUS Chevaline Epistixx CP
- ③ EQUUS Chevaline Epistixx CP
- ④ EQUUS Dymonic 100 sealant
- ⑤ EQUUS Chevaline Dexx bandage

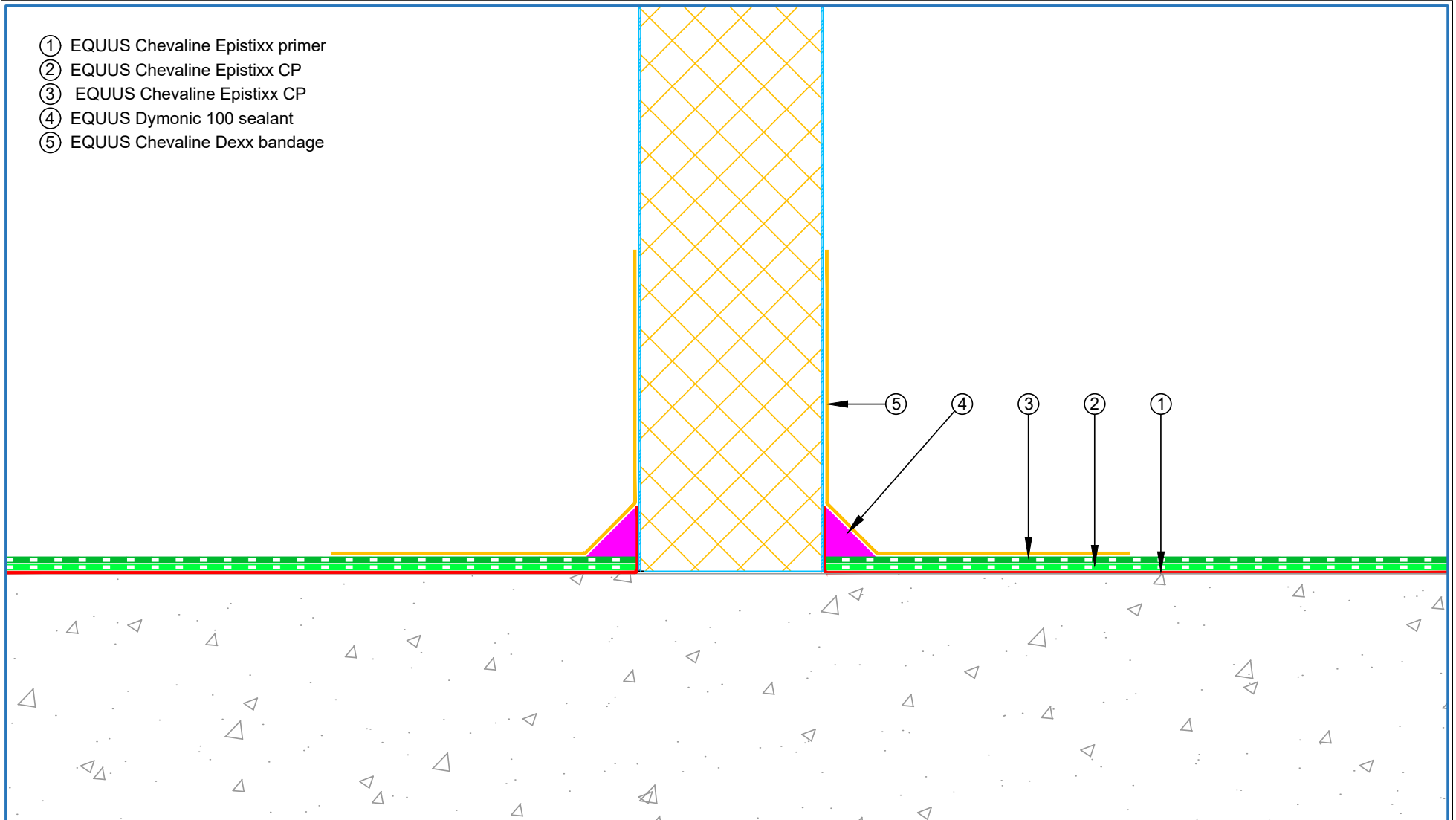

PRODUCT :	Chevaline Epistixx CP Flooring on Concrete Substrate Standard Detail		
TITLE :	Standard cool store panel wall detail		
NUMBER :	ECECP-D6	SCALE :	1:2
DRAWN BY :	NKT	DATE :	15-May-2023
REVISED :			

Equus standard details are especially drawn for use by Local Authorities, Building Contractors, Equus Applicators, Architects and design professionals. All details are drawn to assist in the development of project-specific details. Details may be modified where necessary to accommodate job-specific requirements but must be approved by Equus Industries Ltd. All components must be supplied by Equus Industries Ltd. Equus reserves the right to alter or upgrade details at any time without prior notice.

- ① EQUUS Chevaline Epistixx primer
- ② EQUUS Chevaline Epistixx CP
- ③ EQUUS Chevaline Epistixx CP
- ④ EQUUS Dymonic 100 sealant
- ⑤ Chemset Anchors
- ⑥ Neoprene washers

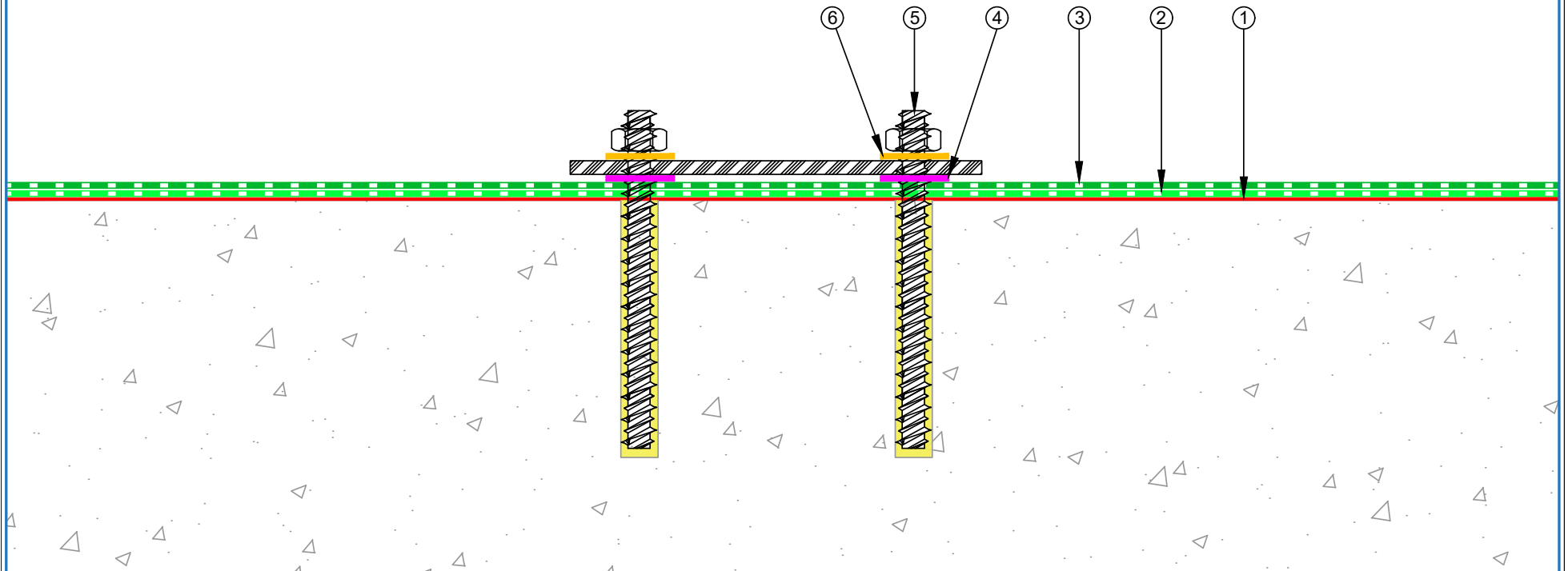

 E-mail : info@equus.nz Web : www.equus.nz	PRODUCT :	Chevaline Epistixx CP Flooring on Interior Concrete Carparks		
	TITLE :	Standard fixing detail		
	NUMBER :	ECECP-D7	SCALE :	NTS
	DRAWN BY :	NKT	DATE :	14-June-2023
			REVISED :	
Equus standard details are especially drawn for use by Local Authorities, Building Contractors, Equus Applicators, Architects and design professionals. All details are drawn to assist in the development of project-specific details. Details may be modified where necessary to accommodate job-specific requirements but must be approved by Equus Industries Ltd. All components must be supplied by Equus Industries Ltd. Equus reserves the right to alter or upgrade details at any time without prior notice.				

- ① EQUUS Chevaline Epistixx primer
- ② EQUUS Chevaline Epistixx CP
- ③ EQUUS Chevaline Epistixx CP
- ④ EQUUS Dymonic 100 sealant
- ⑤ Penetration

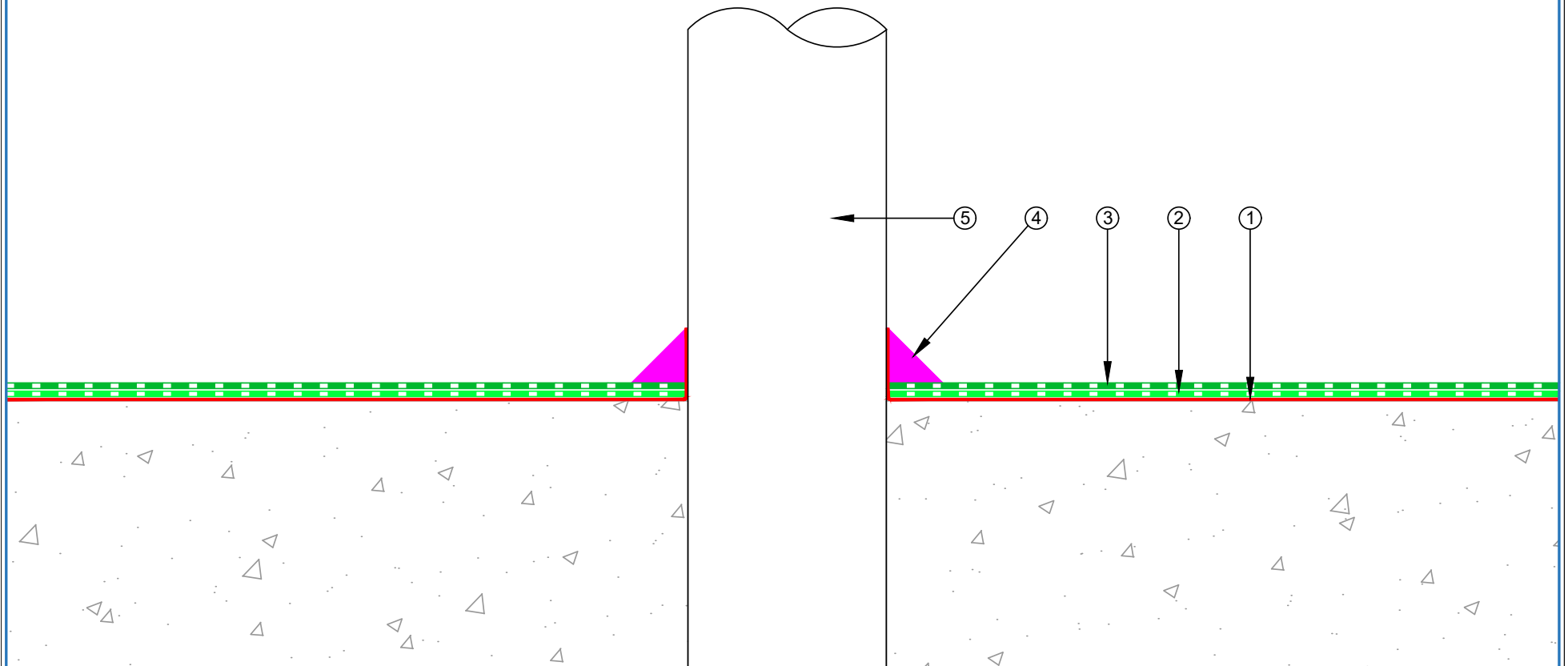

 E-mail : info@equus.nz Web : www.equus.nz	PRODUCT :	Chevaline Epistixx CP Flooring on Interior Concrete Carparks		
	TITLE :	Standard penetration detail		
	NUMBER :	ECECP-D8	SCALE :	1:2
	DRAWN BY :	NKT	DATE :	14-June-2023
	REVISED :			
Equus standard details are especially drawn for use by Local Authorities, Building Contractors, Equus Applicators, Architects and design professionals. All details are drawn to assist in the development of project-specific details. Details may be modified where necessary to accommodate job-specific requirements but must be approved by Equus Industries Ltd. All components must be supplied by Equus Industries Ltd. Equus reserves the right to alter or upgrade details at any time without prior notice.				

- ① EQUUS Chevaline Epistixx primer
- ② EQUUS Chevaline Epistixx CP
- ③ EQUUS Chevaline Epistixx CP
- ④ Mortar fillet
- ⑤ EQUUS Dymonic 100 sealant
- ⑥ Chemset Anchors
- ⑦ Neoprene washers

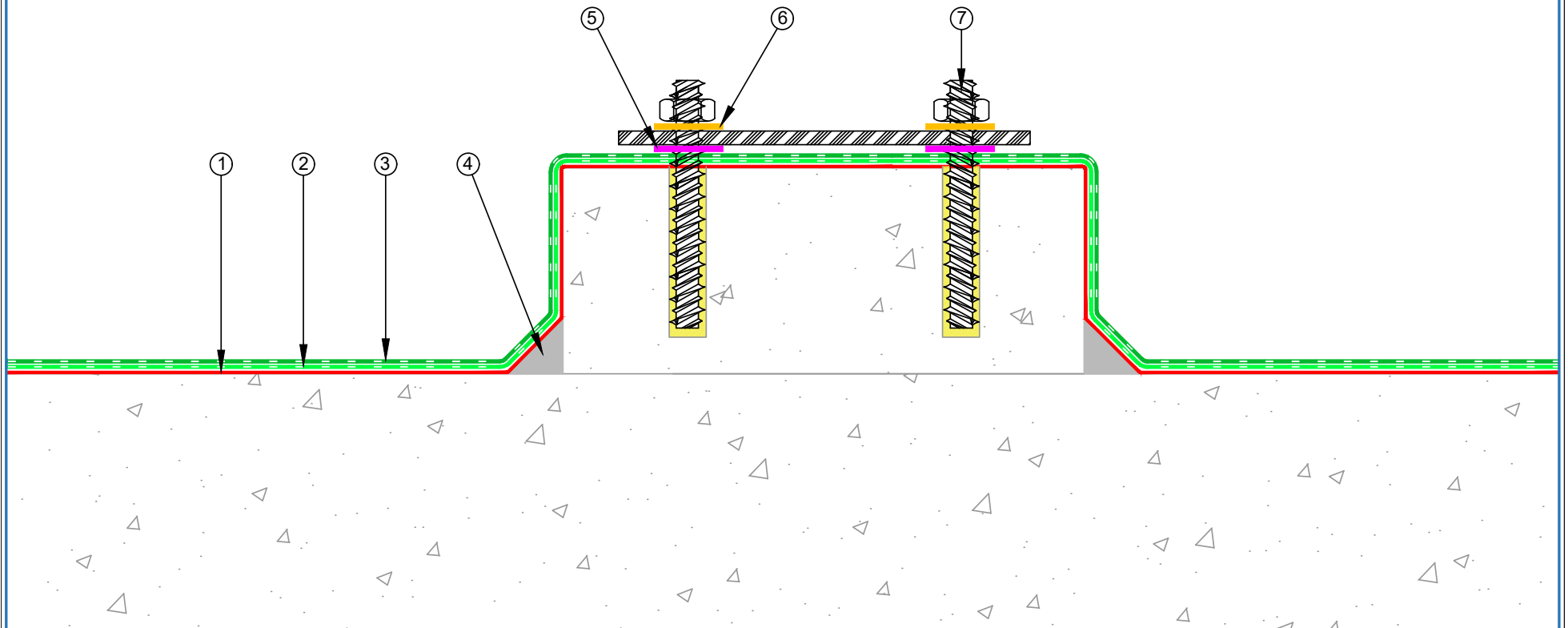

 E-mail : info@equus.nz Web : www.equus.nz	PRODUCT :	Chevaline Epistixx CP Flooring on Interior Concrete Carparks		
	TITLE :	Fixing on plinth Detail		
	NUMBER :	ECECP-D9	SCALE :	NTS
	DRAWN BY :	NKT	DATE :	14-July-2024
	REVISED :			
Equus standard details are especially drawn for use by Local Authorities, Building Contractors, Equus Applicators, Architects and design professionals. All details are drawn to assist in the development of project-specific details. Details may be modified where necessary to accommodate job-specific requirements but must be approved by Equus Industries Ltd. All components must be supplied by Equus Industries Ltd. Equus reserves the right to alter or upgrade details at any time without prior notice.				